



# GigE Area Scan Camera

User Manual

# Legal Information

© 2023 Hangzhou Hikrobot Co., Ltd. All rights reserved.

## About This Manual

The Manual includes instructions for using and managing the Product. Pictures, charts, images and all other information hereinafter are for description and explanation only. The information contained in the Manual is subject to change, without notice, due to firmware updates or other reasons. Please find the latest version of this Manual at the Hikrobot website (<https://en.hikrobotics.com/>). Please use this Manual with the guidance and assistance of professionals trained in supporting the Product.

## Trademarks

**HIKROBOT** and other Hikrobot's trademarks and logos are the properties of Hikrobot in various jurisdictions. Other trademarks and logos mentioned are the properties of their respective owners.

## Disclaimer

TO THE MAXIMUM EXTENT PERMITTED BY APPLICABLE LAW, THIS MANUAL AND THE PRODUCT DESCRIBED, WITH ITS HARDWARE, SOFTWARE AND FIRMWARE, ARE PROVIDED "AS IS" AND "WITH ALL FAULTS AND ERRORS". HIKROBOT MAKES NO WARRANTIES, EXPRESS OR IMPLIED, INCLUDING WITHOUT LIMITATION, MERCHANTABILITY, SATISFACTORY QUALITY, OR FITNESS FOR A PARTICULAR PURPOSE. THE USE OF THE PRODUCT BY YOU IS AT YOUR OWN RISK. IN NO EVENT WILL HIKROBOT BE LIABLE TO YOU FOR ANY SPECIAL, CONSEQUENTIAL, INCIDENTAL, OR INDIRECT DAMAGES, INCLUDING, AMONG OTHERS, DAMAGES FOR LOSS OF BUSINESS PROFITS, BUSINESS INTERRUPTION, OR LOSS OF DATA, CORRUPTION OF SYSTEMS, OR LOSS OF DOCUMENTATION, WHETHER BASED ON BREACH OF CONTRACT, TORT (INCLUDING NEGLIGENCE), PRODUCT LIABILITY, OR OTHERWISE, IN CONNECTION WITH THE USE OF THE PRODUCT, EVEN IF HIKROBOT HAS BEEN ADVISED OF THE POSSIBILITY OF SUCH DAMAGES OR LOSS.

YOU ACKNOWLEDGE THAT THE NATURE OF INTERNET PROVIDES FOR INHERENT SECURITY RISKS, AND HIKROBOT SHALL NOT TAKE ANY RESPONSIBILITIES FOR ABNORMAL OPERATION, PRIVACY LEAKAGE OR OTHER DAMAGES RESULTING FROM CYBER-ATTACK, HACKER ATTACK, VIRUS INFECTION, OR OTHER INTERNET SECURITY RISKS; HOWEVER, HIKROBOT WILL PROVIDE TIMELY TECHNICAL SUPPORT IF REQUIRED. YOU AGREE TO USE THIS PRODUCT IN COMPLIANCE WITH ALL APPLICABLE LAWS, AND YOU ARE SOLELY RESPONSIBLE FOR ENSURING THAT YOUR USE CONFORMS TO THE APPLICABLE LAW. ESPECIALLY, YOU ARE RESPONSIBLE, FOR USING THIS PRODUCT IN A MANNER THAT DOES NOT INFRINGE ON THE RIGHTS OF THIRD PARTIES, INCLUDING WITHOUT LIMITATION, RIGHTS OF PUBLICITY, INTELLECTUAL PROPERTY RIGHTS, OR DATA PROTECTION AND OTHER PRIVACY RIGHTS. YOU SHALL NOT USE THIS PRODUCT FOR ANY PROHIBITED END-USES, INCLUDING THE DEVELOPMENT OR PRODUCTION OF WEAPONS OF MASS DESTRUCTION, THE DEVELOPMENT OR PRODUCTION OF CHEMICAL OR BIOLOGICAL WEAPONS, ANY ACTIVITIES IN THE CONTEXT RELATED TO

ANY NUCLEAR EXPLOSIVE OR UNSAFE NUCLEAR FUEL-CYCLE, OR IN SUPPORT OF HUMAN RIGHTS ABUSES.

THE PERFORMANCE DATA IN THIS PUBLICATION IS BASED ON HIKROBOT'S INTERNAL RESEARCH/EVALUATION. ACTUAL DATA MAY VARY DEPENDING ON SPECIFIC CONFIGURATIONS AND OPERATING CONDITIONS AND HIKROBOT SHALL NOT BEAR THE CONSEQUENCES ARISING THEREFROM.

IN THE EVENT OF ANY CONFLICTS BETWEEN THIS MANUAL AND THE APPLICABLE LAW, THE LATTER PREVAILS.

## Regulatory Information

---

### Note

These clauses apply only to the products bearing the corresponding mark or information.

---

### FCC Information

Please take attention that changes or modification not expressly approved by the party responsible for compliance could void the user's authority to operate the equipment.

### FCC Compliance

This equipment has been tested and found to comply with the limits for a Class A digital device, pursuant to part 15 of the FCC Rules. These limits are designed to provide reasonable protection against harmful interference when the equipment is operated in a commercial environment. This equipment generates, uses, and can radiate radio frequency energy and, if not installed and used in accordance with the instruction manual, may cause harmful interference to radio communications. Operation of this equipment in a residential area is likely to cause harmful interference in which case the user will be required to correct the interference at his own expense.

### FCC Conditions

This device complies with part 15 of the FCC Rules. Operation is subject to the following two conditions:

- This device may not cause harmful interference.
- This device must accept any interference received, including interference that may cause undesired operation.

### EU Conformity Statement



This product and - if applicable - the supplied accessories too are marked with "CE" and comply therefore with the applicable harmonized European standards listed under the Directive 2014/30/EU(EMCD), Directive 2001/95/EC(GPSD) and Directive 2011/65/EU(RoHS).



2012/19/EU (WEEE directive): Products marked with this symbol cannot be disposed of as unsorted municipal waste in the European Union. For proper recycling, return this product to your local supplier

upon the purchase of equivalent new equipment, or dispose of it at designated collection points. For more information see: <http://www.recyclethis.info>



2006/66/EC (battery directive): This product contains a battery that cannot be disposed of as unsorted municipal waste in the European Union. See the product documentation for specific battery information. The battery is marked with this symbol, which may include lettering to indicate cadmium (Cd), lead (Pb), or mercury (Hg). For proper recycling, return the battery to your supplier or to a designated collection point. For more information see: <http://www.recyclethis.info>

Warning: This is a class A product. In a domestic environment this product may cause radio interference in which case the user may be required to take adequate measures.



## KC Mark Certification

Class A: The device is advised to note that as a seller or a business user (Class A) Devices and intended for use outside the Home area.

A급 기기: 이 기기는 업무용(A급) 전자파적합기기로서 판매자 또는 사용자는 이 점을 주의하시기바라며, 가정 외의 지역에서 사용하는 것을 목적으로 합니다.

## Symbol Conventions

The symbols that may be found in this document are defined as follows.

Symbol	Description
 <b>Danger</b>	Indicates a hazard with a high level of risk, which if not avoided, will result in death or serious injury.
 <b>Caution</b>	Indicates a potentially hazardous situation which, if not avoided, could result in equipment damage, data loss, performance degradation, or unexpected results.
 <b>Note</b>	Provides additional information to emphasize or supplement important points of the main text.

## Available Model

This manual is applicable to the GigE area scan camera.

## Contact Information

Hangzhou Hikrobot Co., Ltd.

E-mail: [tech\\_support@hikrobotics.com](mailto:tech_support@hikrobotics.com)

Website: <https://en.hikrobotics.com/>

# Contents

<b>Chapter 1 Safety Instruction .....</b>	<b>1</b>
1.1 Safety Claim .....	1
1.2 Safety Instruction .....	1
1.3 Electromagnetic Interference Prevention.....	3
<b>Chapter 2 Overview .....</b>	<b>4</b>
2.1 Introduction .....	4
2.2 Key Feature.....	4
<b>Chapter 3 Appearance .....</b>	<b>5</b>
<b>Chapter 4 I/O Connector and Indicator.....</b>	<b>9</b>
4.1 Power and I/O Connector .....	9
4.1.1 6-Pin P7 Connector .....	9
4.1.2 12-Pin P10 Connector.....	10
4.2 Indicator .....	11
<b>Chapter 5 Installation .....</b>	<b>13</b>
5.1 Installation Preparation.....	13
5.2 Install Device .....	13
<b>Chapter 6 Device Connection.....</b>	<b>14</b>
6.1 Install MVS Client Software.....	14
6.2 Set PC Environment .....	15
6.2.1 Turn off Firewall .....	15
6.2.2 Set PC Network .....	15
6.3 Set Device Network.....	17
6.4 Connect Device to MVS Client Software .....	18
<b>Chapter 7 Client Software Layout.....</b>	<b>19</b>
<b>Chapter 8 Device Feature.....</b>	<b>22</b>
8.1 Global Shutter .....	22
8.2 Rolling Shutter .....	22
8.3 Sensor Shutter Mode .....	23
8.4 Non-Overlap Exposure and Overlap Exposure.....	25

8.4.1 Non-Overlap Exposure .....	25
8.4.2 Overlap Exposure .....	26
<b>Chapter 9 Image Acquisition .....</b>	<b>27</b>
9.1 Set Frame Rate.....	27
9.2 Set Full Frame Transmission.....	28
9.3 Set Overlap Mode .....	28
9.4 Set Acquisition Mode.....	29
9.5 Set Trigger Mode .....	29
9.5.1 Enable Internal Trigger Mode.....	30
9.5.2 Enable External Trigger Mode .....	30
9.6 Set Trigger Source.....	30
9.7 Set Trigger Related Parameters.....	35
<b>Chapter 10 Trigger Output.....</b>	<b>40</b>
10.1 Select Output Signal.....	40
10.2 Set Output Signal .....	40
10.2.1 Enable Line Inverter.....	40
10.2.2 Enable Strobe Signal.....	41
<b>Chapter 11 I/O Electrical Features and Wiring .....</b>	<b>45</b>
11.1 I/O Electrical Features .....	45
11.1.1 Electrical Features of Input Signal.....	45
11.1.2 Electrical Features of Output Signal.....	46
11.1.3 Electrical Features of Bi-Directional Signal .....	47
11.2 I/O Wiring.....	50
11.2.1 Input Signal Wiring .....	50
11.2.2 Output Signal Wiring .....	51
11.2.3 Bi-Directional Signal Wiring.....	52
<b>Chapter 12 Image Parameter .....</b>	<b>56</b>
12.1 View Resolution.....	56
12.2 Set ROI .....	56
12.3 Set Image Reverse .....	57
12.4 Set Pixel Format .....	58

<b>12.5 Set Super Bayer</b> .....	60
<b>12.6 Set Image Compression Mode</b> .....	60
<b>12.7 Set Test Pattern</b> .....	61
<b>12.8 Set Binning</b> .....	65
<b>12.9 Set Decimation</b> .....	66
<b>12.10 Set Exposure Time Mode</b> .....	66
<b>12.11 Set Exposure Auto</b> .....	67
<b>12.12 Set WDR Mode</b> .....	67
<b>12.13 Set Sequencer Control and HDR</b> .....	68
<b>12.13.1 Set Sequencer</b> .....	68
<b>12.13.2 Set HDR</b> .....	70
<b>12.14 Set Gain</b> .....	71
<b>12.14.1 Set Analog Gain</b> .....	71
<b>12.14.2 Set Digital Gain</b> .....	72
<b>12.15 Set Sensor Mode</b> .....	72
<b>12.16 Set Brightness</b> .....	73
<b>12.17 Set Black Level</b> .....	74
<b>12.18 Set White Balance</b> .....	74
<b>12.19 Set Gamma Correction</b> .....	75
<b>12.20 Set Sharpness</b> .....	77
<b>12.21 Set Digital Noise Reduction</b> .....	77
<b>12.22 Set Channel Correct Mode</b> .....	78
<b>12.23 Set Contrast Ratio</b> .....	78
<b>12.24 Set AOI</b> .....	79
<b>12.25 Set Color Transformation Control</b> .....	80
<b>12.26 Set Hue</b> .....	81
<b>12.27 Set Saturation</b> .....	82
<b>12.28 Set Super Palette Control</b> .....	83
<b>12.29 Set LUT</b> .....	84
<b>12.30 Set Shading Correction</b> .....	84
<b>12.30.1 LSC Correction</b> .....	85

12.30.2 Other Corrections .....	86
<b>Chapter 13 Other Functions .....</b>	<b>88</b>
13.1 Device Control.....	88
13.2 Embed Information into Image .....	90
13.3 Set Action Command.....	94
13.4 File Access Control .....	95
13.5 Event Control.....	96
13.6 Transport Layer Control .....	98
13.7 Transfer Control .....	102
13.7.1 User Controlled Transfer Control .....	102
13.7.2 Basic Transfer Control .....	104
13.8 Set Cooling Fan .....	104
13.9 User Set Customization .....	105
13.9.1 Save User Set .....	105
13.9.2 Load User Set .....	106
13.9.3 Set User Default .....	107
13.10 Multicast Function .....	107
13.10.1 Set Multicast (Available Status) .....	107
13.10.2 Set Multicast (Connected Status) .....	108
13.11 Update Firmware .....	109
13.12 Encrypt Device via Dongle Tool .....	110
<b>Chapter 14 FAQ (Frequently Asked Question) .....</b>	<b>112</b>
14.1 Why the client software cannot list devices? .....	112
14.2 Why device connection fails after the device is listed in the client software? ..	112
14.3 Why the live view is back? .....	112
14.4 Why the device cannot be triggered although the live view is normal?.....	113
14.5 Why the network changes from GigE Ethernet to Fast Ethernet? .....	113
<b>Appendix A Device Parameter Index.....</b>	<b>114</b>
<b>Appendix B Revision History .....</b>	<b>124</b>



# Chapter 1 Safety Instruction

The safety instructions are intended to ensure that the user can use the device correctly to avoid danger or property loss. Read and follow these safety instructions before installing, operating and maintaining the device.

## 1.1 Safety Claim

- To ensure personal and device safety, when installing, operating, and maintaining the device, follow the signs on the device and all safety instructions described in the manual.
- The note, caution and danger items in the manual do not represent all the safety instructions that should be observed, but only serve as a supplement to all the safety instructions.
- The device should be used in an environment that meets the design specifications, otherwise it may cause malfunctions, and malfunctions or component damage caused by non-compliance with relevant regulations are not within the scope of the device's quality assurance.
- Our company will not bear any legal responsibility for personal safety accidents and property losses caused by abnormal operation of the device.

## 1.2 Safety Instruction

### **Caution:**

- Do not install the device if it is found that the device and accessories are damaged, rusted, water ingress, model mismatch, missing parts, etc., when unpacking.
- Avoid storage and transportation in places such as water splashing and rain, direct sunlight, strong electric fields, strong magnetic fields, and strong vibrations.
- Avoid dropping, smashing or vigorously vibrating the device and its components.
- It is forbidden to install the indoor device in an environment where it may be exposed to water or other liquids. If the device is damp, it may cause fire and electric shock hazard.
- Place the device in a place out of direct sunlight and ventilation, away from heat sources such as heaters and radiators.
- In the use of the device, you must be in strict compliance with the electrical safety regulations of the nation and region.
- Use the power adapter provided by the official manufacturer. The power adapter must meet the Limited Power Source (LPS) requirements. For specific requirements, please refer to the device's technical specifications.
- If the device emits smoke, odor or noise, please turn off the power and unplug the power cord immediately, and contact the dealer or service center in time.

- It is strictly forbidden to touch any terminal of the device when operating it. Otherwise there is a danger of electric shock.
- It is strictly forbidden for non-professional technicians to detect signals during device operation, otherwise it may cause personal injury or device damage.
- It is strictly forbidden to maintain the device is powered on, otherwise there is a danger of electric shock.
- Avoid aiming the lens at strong light (such as lighting, sunlight, or laser beams, etc.), otherwise the image sensor will be damaged.
- If it is necessary to clean the device, use a damp paper towel or a soft clean cloth to moisten a little pure water, gently wipe off the dust, and do not use alcohol-based corrosive solutions. Make sure to power off the device and unplug the power socket when cleaning.
- Keep clean of the device's image acquisition window. It is recommended to use cleaning water to wipe off the dust.
- If the device does not work properly, please contact your dealer or the nearest service center. Never attempt to disassemble the device yourself (we shall not assume any responsibility for problems caused by unauthorized repair or maintenance).
- Please dispose of the device in strict accordance with the relevant national or regional regulations and standards to avoid environmental pollution and property damage.

### **Note:**

- Check whether the device's package is in good condition, whether there is damage, intrusion, moisture, deformation, etc. before unpacking.
- Check the surface of the device and accessories for damage, rust, bumps, etc. when unpacking.
- Check whether the quantity and information of the device and accessories are complete after unpacking.
- Store and transport the device according to the storage and transport conditions of the device, and the storage temperature and humidity should meet the requirements.
- It is strictly prohibited to transport the device in combination with items that may affect or damage the device.
- Quality requirements for installation and maintenance personnel:
  - Qualification certificate or working experience in weak current system installation and maintenance, and relevant working experience and qualifications. Besides, the personnel must possess the following knowledge and operation skills.
  - The basic knowledge and operation skills of low voltage wiring and low voltage electronic circuit connection.
  - The ability to comprehend the contents of this manual.
- Please read the manual and safety instructions carefully before installing the device.
- Please install the device strictly according to the installation method in this manual.
- The case of the device may be overheated, and it needs to be powered off for half an hour before it can be touched.
- The device should not be placed with exposed flame sources, such as lighted candles.

## 1.3 Electromagnetic Interference Prevention

- Make sure that the shielding layer of cables is intact and 360° connected to the metal connector when using shielded cables.
- Do not route the device together with other equipment (especially servo motors, high-power devices, etc.), and control the distance between cables to more than 10 cm. Make sure to shield the cables if unavoidable.
- The control cable of the device and the power cable of the industrial light source must be wired separately to avoid bundled wiring.
- The power cable, data cable, signal cable, etc. of the device must be wired separately. Make sure to ground them if the wiring groove is used to separate the wiring and the wiring groove is metal.
- During the wiring process, evaluate the wiring space reasonably, and do not pull the cables hard, so as not to damage the electrical performance of the cables.
- If the device is powered on and off frequently, it is necessary to strengthen the voltage isolation, and consider adding a DC/DC isolation power supply module between the device and the adapter.
- Use the power adapter to supply power to the device separately. If centralized power supply is necessary, make sure to use a DC filter to filter the power supply of the device separately before use.
- The unused cables of the device must be insulated.
- When installing the device, if you cannot ensure that the device itself and all equipment connected to the device are well grounded, you should isolate the device with an insulating bracket.
- To avoid the accumulation of static electricity, ensure that other equipment (such as machines, internal components, etc.) and metal brackets on site are properly grounded.
- Make sure that the connector metal barrier of the device is well connected to the PC and other chassis, and if necessary, copper foil should be used to enhance the grounding effect.
- During the installation and use of the device, high voltage leakage must be avoided.
- Use a figure-eight bundle method if the device cable is too long.
- When connecting the device and metal accessories, they must be connected firmly to maintain good conductivity.
- Use a shielded network cable to connect to the device. If you use a self-made network cable, make sure that the shielding shell at the aviation head is well connected to the aluminum foil or metal braid of the shielding cable.

## Chapter 2 Overview

### 2.1 Introduction

The GigE area scan camera uses the GigE interface to transmit non-compressed images in real time, and it acquires images and sets parameters via the client software or SDK. The GigE area scan camera is applicable to the automated optical inspection (AOI) for the surface mounted technology and the printed circuit board, electronic semiconductor, factory automation, logistics industry, etc.

### 2.2 Key Feature

- Supports auto and manual adjustment for gain, exposure time and white balance, manual adjustment for Look-Up Table (LUT), Gamma correction, etc.
- Adopts the image interpolation algorithm for the color reproduction.
- Supports the hardware trigger, software trigger, free run, etc.
- Adopts GigE interface and max. transmission distance of 100 meters without relay.
- Compatible with the GigE Vision Protocol, the GenICam Standard, and the third-party software based on the protocol and standard.

---

#### Note

- The specific functions may differ by device models.
  - Refer to the device's specifications for specific parameters.
-

## Chapter 3 Appearance

### Note

- For specific appearance and dimension, please refer to the device's specification for details.
- The appearance is subject to change, and the actual device you purchased shall prevail.
- TEC stands for Thermo-Electric Cooler that is able to keep the device's sensor temperature around environment temperature to ensure the normal operation of the device.

The specific device appearance types are as follows:

- Type I device: It is a device with dimension of 29 mm × 29 mm × 42 mm.
- Type II device: It is a device with dimension of 29 mm × 29 mm × 42 mm, and it can be mounted from four sides.
- Type III device: It is CU series device with dimension of 29 mm × 29 mm × 42 mm.
- Type IV device: It is a device with dimension of 29 mm × 44 mm × 59 mm.
- Type V device: It is an industrial short wave infrared device with C-mount and TEC function.
- Type VI device: It is a device with M58-mount, but has no cooling fan.
- Type VII device: It is a device with F-mount, but has no cooling fan.
- Type VIII device: It is a device with M58-mount, and has cooling fan.
- Type IX device: It is a device with F-mount, and has cooling fan.

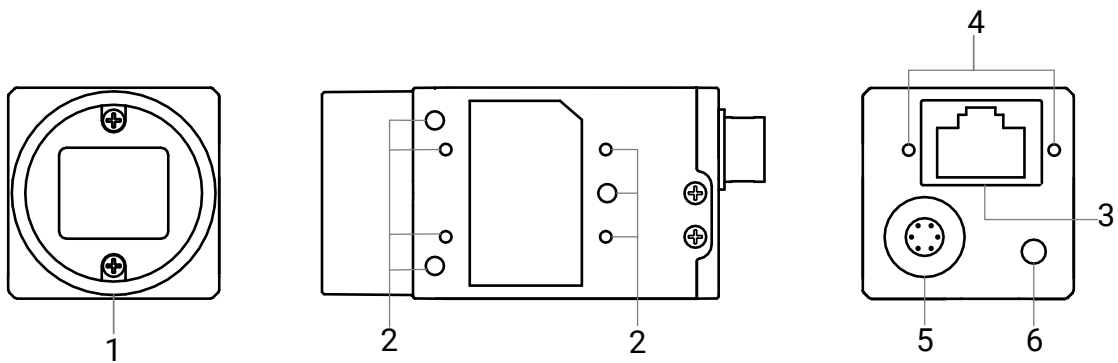

Figure 3-1 Appearance (Type I)

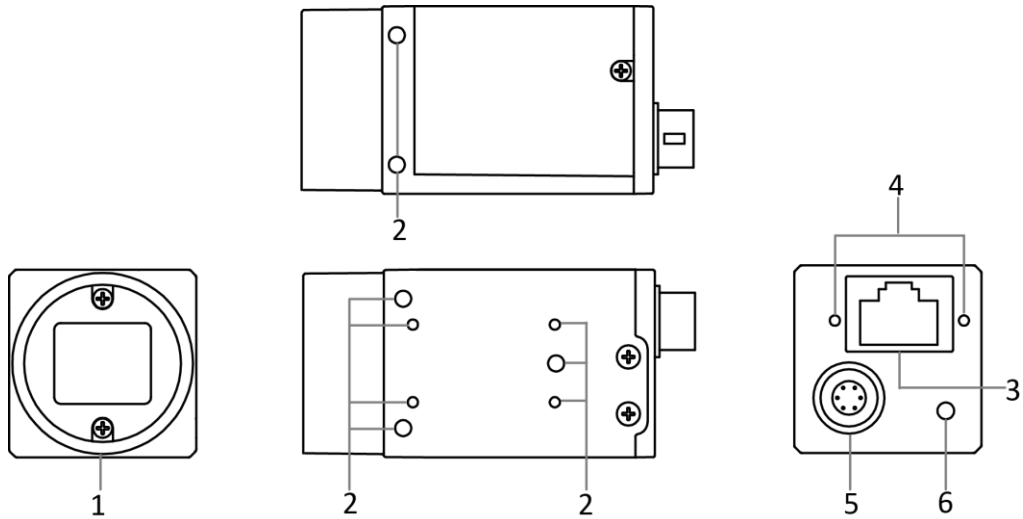

Figure 3-2 Appearance (Type II)

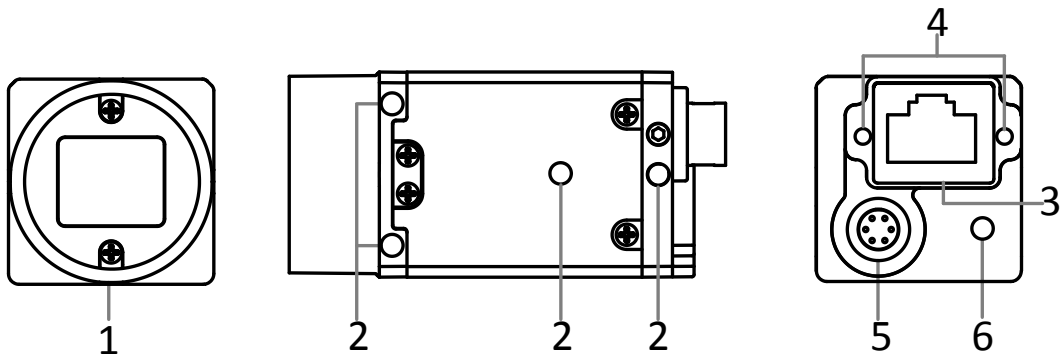

Figure 3-3 Appearance (Type III)

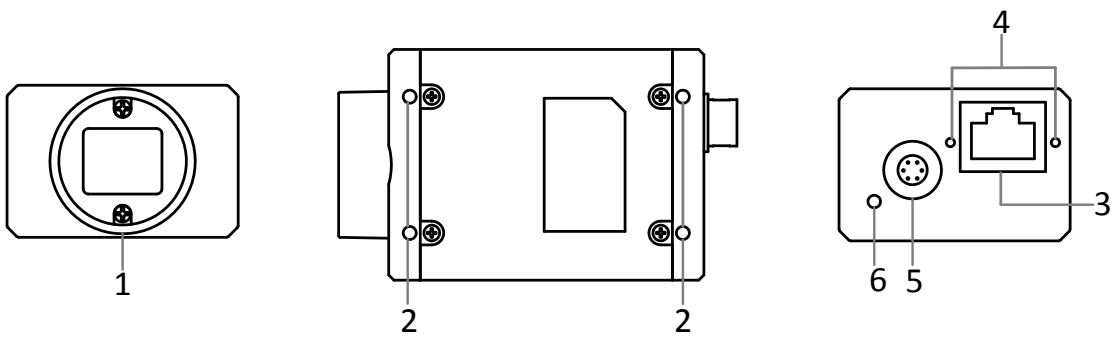
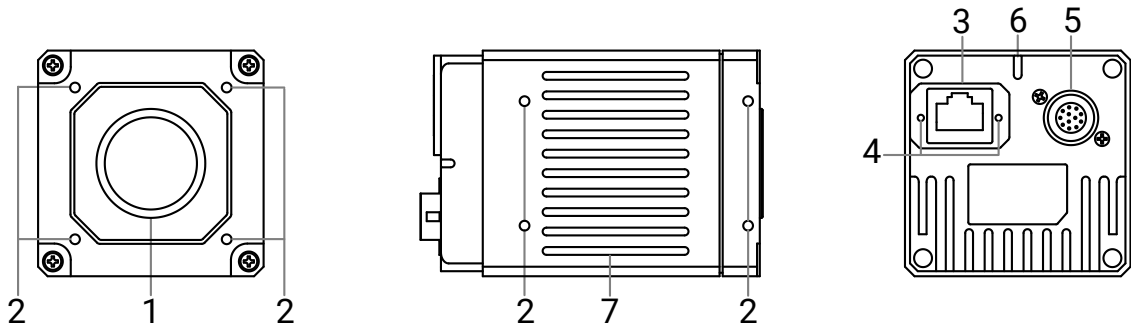
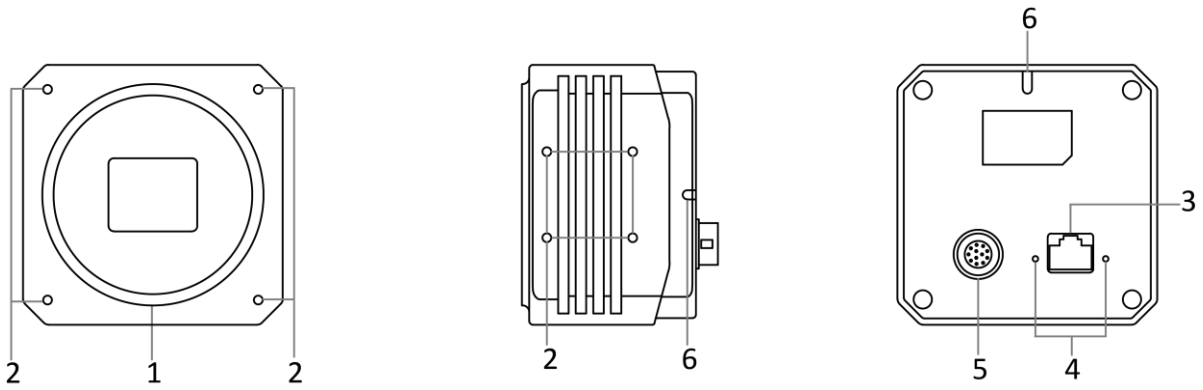

Figure 3-4 Appearance (Type IV)



**Figure 3-5 Appearance (Type V)**



**Figure 3-6 Appearance (Type VI)**

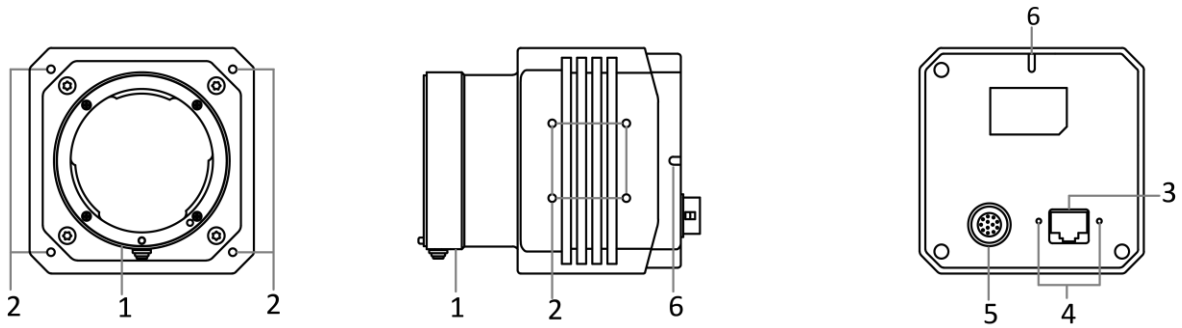

**Figure 3-7 Appearance (Type VII)**

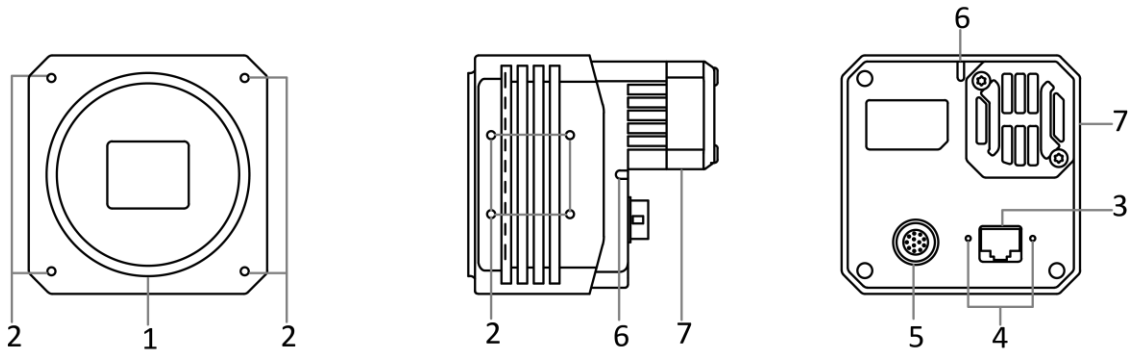

Figure 3-8 Appearance (Type VIII)

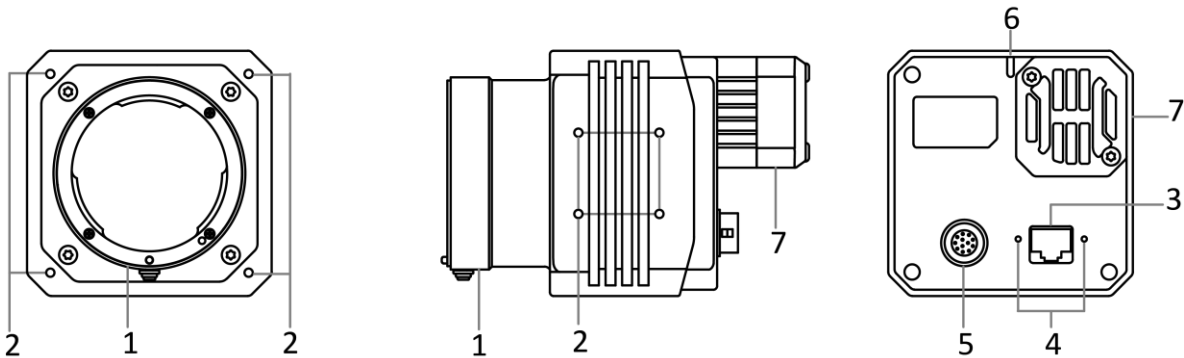

Figure 3-9 Appearance (Type IX)

Table 3-1 Component Description

No.	Component	Description
1	Lens Mount	It is used to install the lens. Refer to the device's specification for specific lens mount information.
2	Screw Hole	It is used to fix the device to the installation position. Refer to the device's specification for specific screw information.
3	GigE Interface	It refers to the GigE interface for transmitting data.
4	Screw Hole of GigE Interface	It refers to the M2 screw hole for fixing the network cable.
5	Power and I/O Connector	It provides power supply, input/output signal and serial port function.
6	LED Indicator	It indicates the device's status.
7	Cooling Fan or TEC	It is used to cool the device to ensure its normal operation.



## Chapter 4 I/O Connector and Indicator

### 4.1 Power and I/O Connector

The device has a 6-pin P7 connector or 12-pin P10 connector as the power and I/O connector that provides power supply, input/output signal and serial port function.

#### 4.1.1 6-Pin P7 Connector

The 6-pin P7 connector is applicable to type I, type II, type III, and type IV devices.

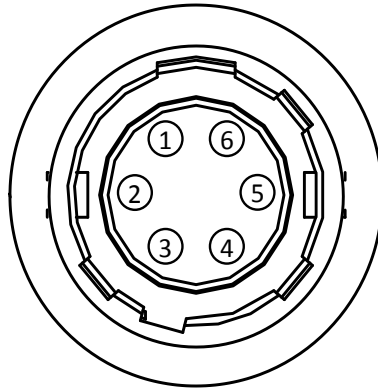

Figure 4-1 6-Pin P7 Connector

#### Note

Refer to the table below and the label attached to the power and I/O cable to wire the device.

Table 4-1 Pin Definitions of 6-Pin P7 Connector

No.	Signal	I/O Signal Source	Description
1	DC_PWR	--	Device's power supply
2	OPTO_IN	Line 0+	Opto-isolated input
3	GPIO	Line 2+	Can be configured as input or output
4	OPTO_OUT	Line 1+	Opto-isolated output
5	OPTO_GND	Line 0-/1-	Opto-isolated signal ground
6	GND	Line 2-	Device's power supply ground

### 4.1.2 12-Pin P10 Connector

The 12-pin P10 connector is applicable to type V, type VI, type VII, type VIII, and type IX devices, as shown below. However, the specific pin definitions differ by device models. Currently, two types of 12-pin P10 connector definition are available.

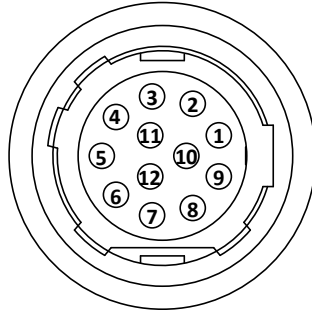

Figure 4-2 12-Pin P10 Connector

#### First Type of 12-Pin P10 Connector Definition

The first type of 12-pin P10 connector definition is shown below.

**Note**

Refer to the table below and the label attached to the power and I/O cable to wire the device.

Table 4-2 First Type of 12-Pin P10 Connector Definition

No.	Signal	I/O Signal Source	Description
1	GND	Line 2-	Device's power supply ground
2	DC_PWR	--	Device's power supply
3	Reserved		
4	Reserved		
5	OPTO_GND	Line 0-/1-	Opto-isolated signal ground
6	Reserved		
7	Reserved		
8	RS-232_RX	--	RS-232 receives
9	RS-232_TX	--	RS-232 transmits
10	GPIO	Line 2+	Can be configured as input or output
11	OPTO_OUT	Line 1+	Opto-isolated output
12	OPTO_IN	Line 0+	Opto-isolated input

## Second Type of 12-Pin P10 Connector Definition

The second type of 12-pin P10 connector definition is shown below.

---

### Note

Refer to the table below and the label attached to the power and I/O cable to wire the device.

---

**Table 4-3 Second Type of 12-Pin P10 Connector Definition**

No.	Signal	I/O Signal Source	Description
1	GND	Line 2-	Device power supply ground
2	DC_PWR	--	Device power supply
3	DC_PWR	--	Device power supply
4	OPT_IN-	Line 0-	Opto-isolated input signal ground
5	OPT_OUT-	Line 1-	Opto-isolated output signal ground
6	GND	--	Device power supply ground
7	GND	--	Device power supply ground
8	232_RXD	--	RS-232 receives
9	232_TXD	--	RS-232 transmits
10	GPIO2	Line 2+	Input or output
11	OPT_OUT+	Line 1+	Opto-isolated output
12	OPT_IN+	Line 0+	Opto-isolated input

## 4.2 Indicator

The device's indicator is used to indicate the operation status of the device.

---

### Note

- The indicator status may differ by device models, and actual devices you purchased shall prevail.
  - When the indicator is flashing rapidly, flashing slowly, or flashing very slowly, its unlit interval is 0.2 sec, 1 sec, and 2 sec respectively.
  - The indicator sometimes may show a purple color when red and blue colors flashing at the same time.
-

**Table 4-4 Indicator Description**

<b>No.</b>	<b>Indicator Color</b>	<b>Status</b>	<b>Device Status Description</b>
1	Red	Flashing very slowly	The device's wiring exception occurs.
2	Red	Solid	The device exception occurs.
3	Blue	Flashing slowly	The device is acquiring images in trigger mode.
4	Blue	Flashing rapidly	The device is acquiring images normally.
5	Blue	Solid	The device is in an idle status.
6	Red and blue	Flash alternatively	The function of finding me is executed, or the firmware is updating.

## Chapter 5 Installation

### 5.1 Installation Preparation

You need to prepare following accessories before device installation.

**Table 5-1 Accessories**

No.	Name	Quantity	Description
1	Power and I/O Cable	1	It refers to the 6-pin or 12-pin power and I/O cable. You need to purchase separately.
2	DC Power Supply	1	You should select suitable power adapter or switch power supply according to the device power supply and consumption. You need to purchase separately.
3	Network Cable	1	It refers to CAT-5e network cable or above. You need to purchase separately.
4	Lens	1	It refers to the lens that is suitable for the device. You need to purchase separately.
5	Lens Adapter	1	If the lens you used does not match with lens mount of the device, you need to use a lens adapter. You need to purchase separately.

### 5.2 Install Device

#### **Before You Start**

- Make sure that the device in package is in good condition and all assembly parts are included.
- Make sure that all related devices are powered off during the installation.

#### **Steps**

1. Fix the device to the installation position.
2. Install the lens to the device.
3. Use a proper network cable to connect device with a GigE switch or a network interface card.
4. Select a power supply method:
  - Direct power supply: Use the 6-pin or 12-pin power and I/O cable to connect device to a proper power adapter.
  - PoE (Power over Ethernet): For the device that supports PoE, use a network cable to connect the device to a switch that supports PoE or a network interface card.

## Chapter 6 Device Connection

Device connection to the client software is required for device's configurations and remote operations. This section introduces how to install the client software, connect the device to the client software, etc.

### 6.1 Install MVS Client Software

MVS client software is used to connect and set device's parameters, and acquire images.

---

#### Note

- The MVS client software is compatible with 32/64-bit Windows XP/7/10, 32/64-bit Linux, and 64-bit MacOS operating systems. Here we take Windows as an example.
  - The graphic user interface may differ by different versions of the client software you use.
  - You can download the client software from [en.hikrobotics.com](http://en.hikrobotics.com).
- 

#### Steps

1. Double click the MVS installation package.
2. Select the language.
3. Read and check **Terms of the License Agreement**.

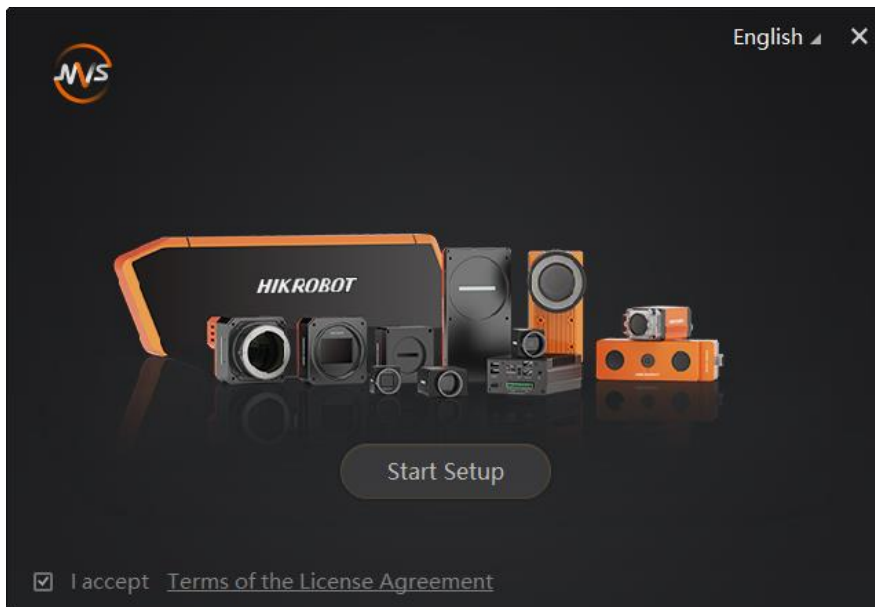

Figure 6-1 Installation Interface

4. Click **Start Setup**.
5. Keep default settings, and click **Next**.
6. Finish the installation according to the interface prompts.

## 6.2 Set PC Environment

To ensure stable client running and data transmission, you are recommended to set PC environment.

### 6.2.1 Turn off Firewall

#### Steps

---

#### Note

For different Windows versions, the path name or interface may differ. Please refer to the actual condition.

---

1. Go to Windows Firewall.
  - Windows XP system: Click **Start** → **Control Panel** → **Security Center** → **Windows Firewall**.
  - Windows 7 system: Click **Start** → **Control Panel** → **Windows Firewall**.
  - Windows 10 system: Click **Start** → **Control Panel** → **System and Security** → **Windows Defender Firewall**.
2. Click **Turn Windows Defender Firewall on or off** on the left.
3. Select **Turn off Windows Defender Firewall (not recommended)**.

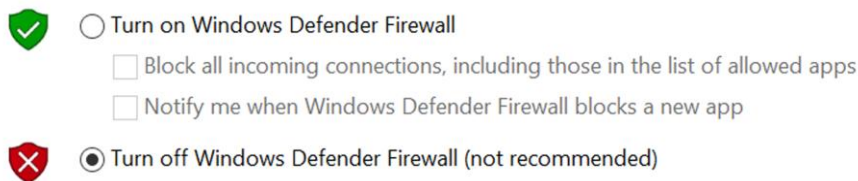

**Figure 6-2 Windows Defender Firewall**

4. Click **OK**.

### 6.2.2 Set PC Network

#### Steps

---

#### Note

For different Windows versions, the specific setting path and interface may differ. Please refer to the actual condition.

---

1. Go to PC network settings page: **Start** → **Control Panel** → **Network and Internet** → **Network and Sharing Center** → **Change adapter settings**.
2. Select NIC and set the IP obtainment mode.

- Select **Obtain an IP address automatically** to get an IP address of the PC automatically.
- Or select **Use the following IP address** to set an IP address for the PC manually.

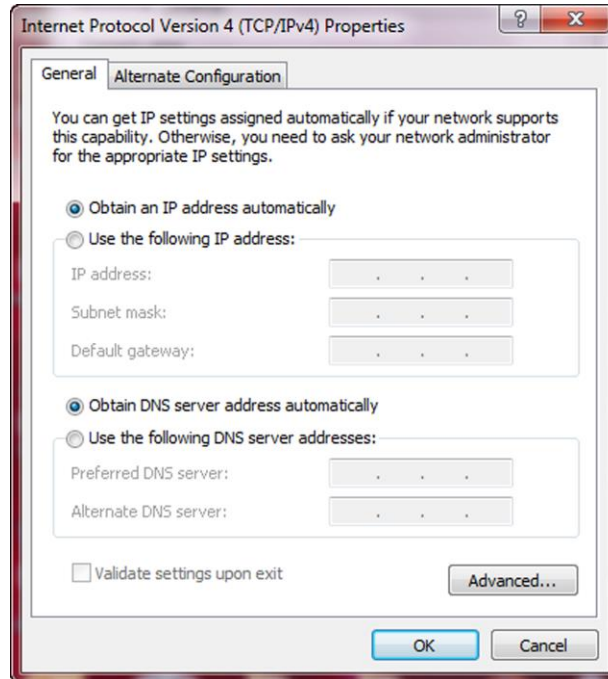

**Figure 6-3 Set PC Network**

3. Set NIC property via the PC.

1) Go to NIC settings page: **Control Panel** → **Hardware and Sound** → **Device Manager** → **Network Adapter**.

2) Select corresponding network interface card, and click **Advanced**.

3) Set **Jumbo Packet** value to 9014 Bytes, **Transmit Buffers** and **Receive Buffers** to 2048, **Interrupt Moderation Rate** to **Extremum**.

4. (Optional) Set NIC property via the MVS.

1) Right click the **GigE**, and click **NIC Settings**.

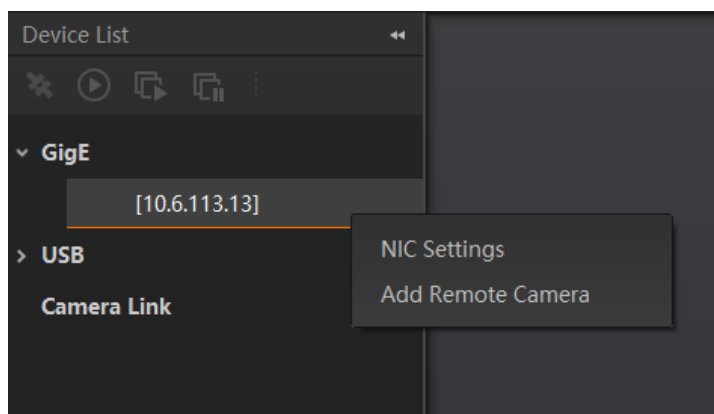

**Figure 6-4 Click NIC Settings**

2) Enable **Jumbo Frame**, and set **Receive Buffers** and **Transmit Buffers** to 2048.



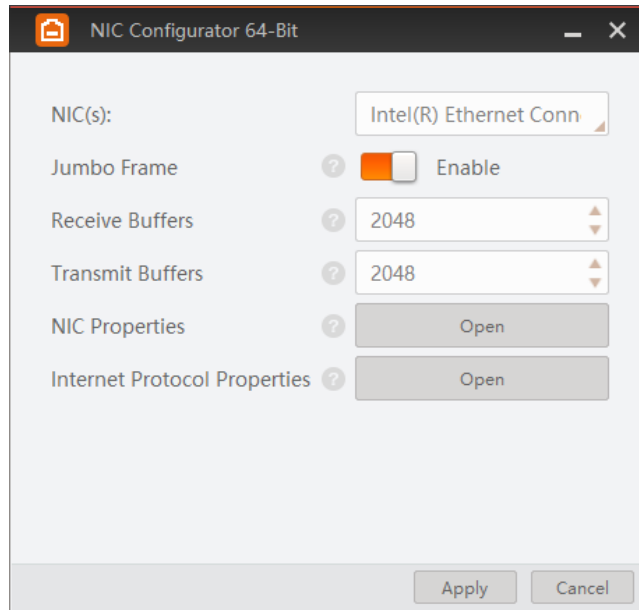

**Figure 6-5 NIC Configurator**

---

### Note

The max. value of receive buffers and transmit buffers may differ by network interface cards.

---

## 6.3 Set Device Network

You can set and operate the device in the client software only when the device is in the same network segment with the PC where the client software is installed.

### Steps

1. Double click the client software to run it.
2. Click  in device list to search the device.
3. Select a device to be connected.
4. Right click the device and click **Modify IP**.
5. Set the IP address of the device in the same network segment with the PC.
6. Click **OK**.

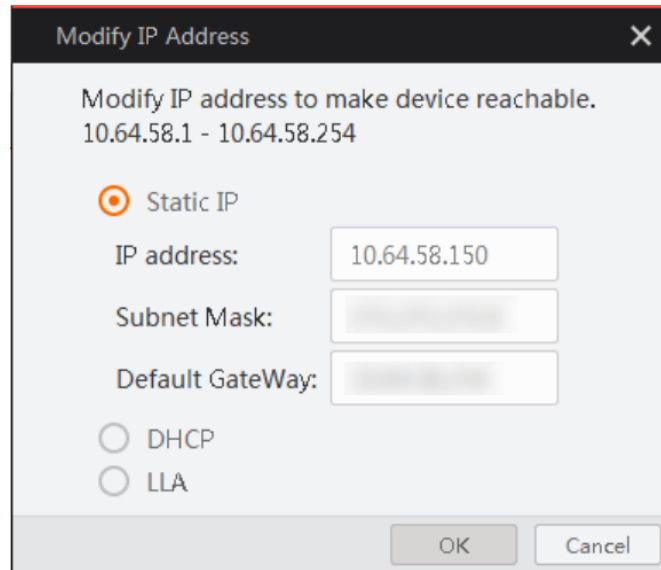

Figure 6-6 Set Device Network

## 6.4 Connect Device to MVS Client Software

---

### Note

Make sure that your device's IP address is in the same network segment with the PC where you installed the client software before connecting the device to it.

---

Double click the device name in the device list, or click  to connect the device to the client software.

## Chapter 7 Client Software Layout

After connecting to the device, the client software can read its attributes and display them.

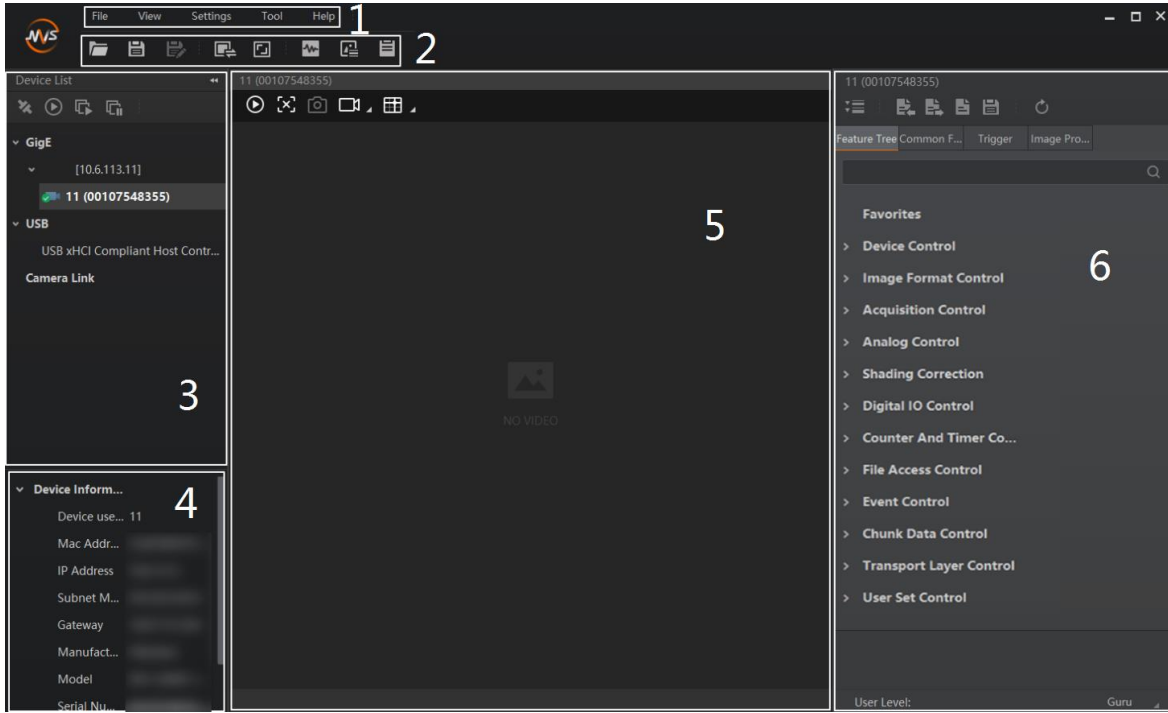

Figure 7-1 Main Window

**Note**

For specific main window of the client software, please refer to the actual one you got.

Table 7-1 Main Window Description

No.	Name	Description
1	Menu Bar	The menu bar displays function modules, including File, View, Settings, Tool, and Help.
2	Control Toolbar	The control toolbar provides quick operations for the device.
3	Device List Panel	This panel displays device list, and you can connect or disconnect device, modify device IP address, etc.
4	Device Information Panel	This panel displays the detailed device information.
5	Display Window	This area displays the acquisition images in real-time. You can click different icons to capture and save image, record, etc.

No.	Name	Description
6	Feature Panel	You can view and set features of the selected device, and perform operations such as importing, exporting, and saving features.

Click  in the device's feature panel to unfold the specific parameters, and set them according to actual demands.

---

 **Note**

The device's feature tree and parameters may differ by device models.

---

**Table 7-2 Feature Tree Description**

Feature Name	Description
Device Control	You can view the device information, edit its name, reset the device, etc.
Image Format Control	You can view and set the device's resolution, image reverse function, pixel format, region of interest, test pattern, etc.
Acquisition Control	You can view and set the device's acquisition mode, frame rate, trigger mode, exposure time, etc.
Analog Control	You can view and set the device's gain, black level, Gamma correction, sharpness, etc.
Color Transformation Control	You can view and set the device's color transformation related parameters like hue and saturation.
LUT Control	You can view the Look-Up Table (LUT), and set its index and value.
Shading Correction	You can set shading correction to correct shade.
Digital IO Control	You can set the different input and output signals.
Action Control	You can view and set the device's action control related parameters.
Counter and Timer Control	You can view and set the counter-related parameters.
File Access Control	You can view and set the device's file access control related parameters.
Sequencer Control	You can view and set the device's sequencer related parameters.
Event Control	You can view and set the device's event control related parameters to let the device generate an event and transmit a related event message to the computer.

Feature Name	Description
Chunk Data Control	You can view and set the device's chunk data control related parameters to generate supplementary image data and append that data to every image that you acquire.
Transport Layer Control	You can view and set the parameters of the device's transport layer.
Transfer Control	You can view and set the parameters of the device's transfer control.
User Set Control	You can save or load the device's parameters.

## Chapter 8 Device Feature

### 8.1 Global Shutter

For device that supports global shutter, its exposure starts and ends in each line simultaneously. After the exposure, data readout starts line by line. All pixels expose at the same time, then readout at different time.

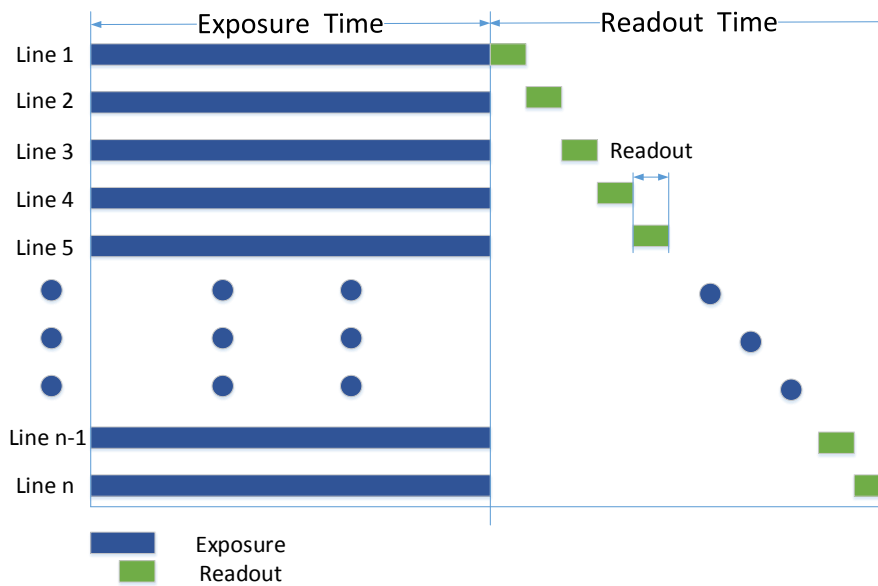

Figure 8-1 Global Shutter

### 8.2 Rolling Shutter

For device that supports rolling shutter, as soon as the exposure ends, the data readout starts simultaneously. After the whole action, the rest of rows start to expose and read out one by one. All pixels expose at the same time, then readout at different time.

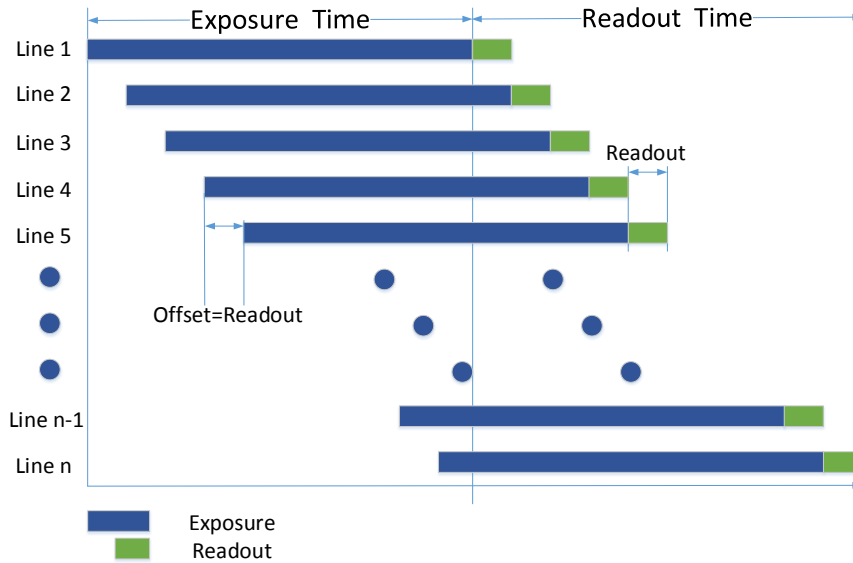

Figure 8-2 Rolling Shutter

## 8.3 Sensor Shutter Mode

### Note

- Only some models of devices with rolling shutter and corresponding firmware support the sensor shutter mode. The actual product you purchased should prevail.
- Stopping the real-time acquisition is required before setting the sensor shutter mode.
- For some device models, only when **Trigger Mode** is **On**, you can set **Sensor Shutter Mode**.

The sensor shutter mode allows you to set the operating mode of the device's electronic shutter. The shutter mode refers to the way in which the image data is captured and processed.

In general, there are 3 sensor shutter modes, including **Global Reset**, **Rolling** and **Trigger Rolling**. Global reset means that all of the sensor's pixels start exposing at the same time, but stop exposing at different time.

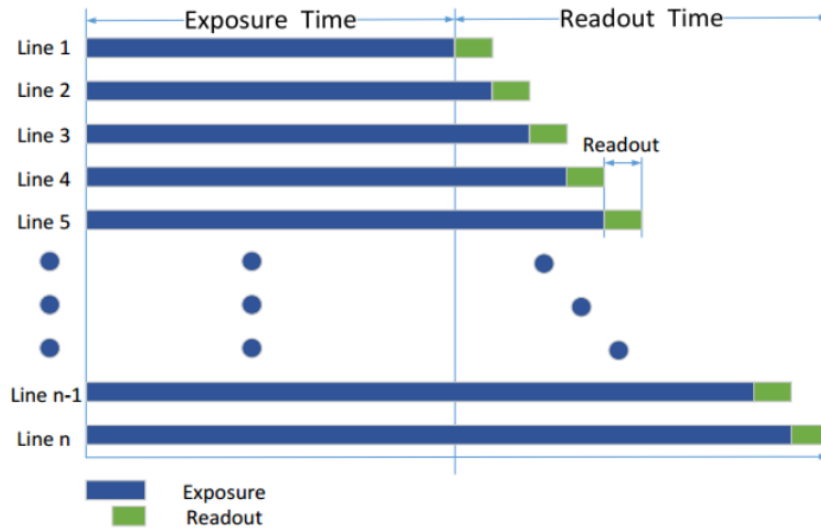

**Figure 8-3 Global Reset**

Rolling means that the device exposes the pixel rows one after the other, and it supports sensor's pixels exposure and pixel data readout proceeding at the same time. While trigger rolling does not support that sensor's pixels exposure and pixel data readout proceed at the same time.

You can go to **Acquisition Control** → **Sensor Shutter Mode**, and select **Sensor Shutter Mode** according to actual demands.

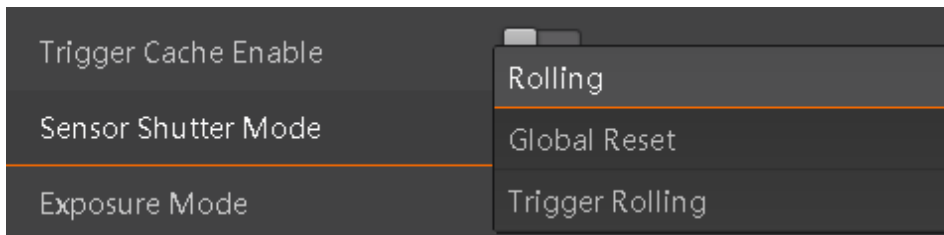

**Figure 8-4 Sensor Shutter Mode**



## 8.4 Non-Overlap Exposure and Overlap Exposure

The process that the device captures one frame of image includes two stages, exposure and readout. According to the overlap relation between the exposure time and the readout time, devices with different sensors can be divided into overlap exposure and non-overlap exposure.

### 8.4.1 Non-Overlap Exposure

After completing the current frame's exposure and readout, the next frame starts to expose and read out. This process is called non-overlap exposure. The non-overlap exposure's frame period is larger than the sum of the exposure time and the readout time, as shown below.

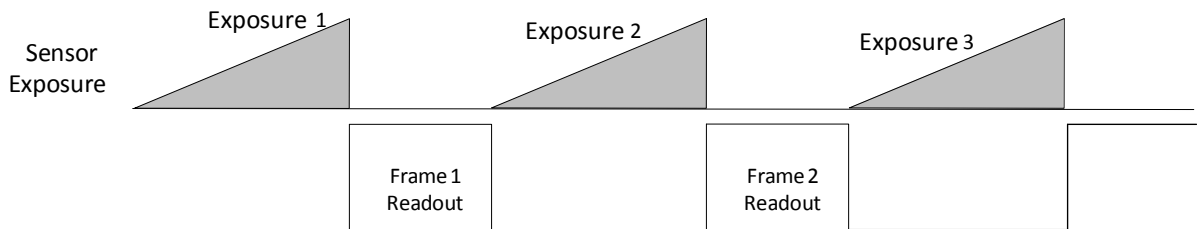

Figure 8-5 Internal Trigger Non-Overlap Exposure

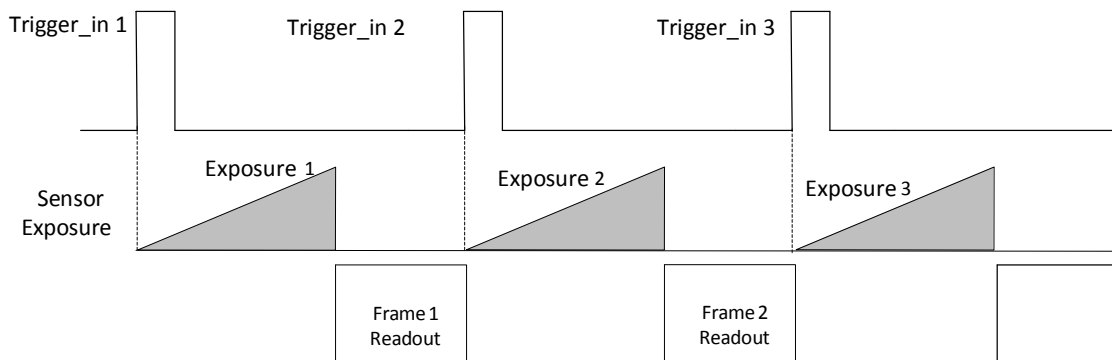

Figure 8-6 External Trigger Non-Overlap Exposure

**Note**

The device will ignore the external signal in the readout section under this mode.

### 8.4.2 Overlap Exposure

Overlap exposure refers to the overlap between the current frame exposure and the previous frame readout. In other words, when the previous frame starts to read out, the current frame starts to expose simultaneously, as shown below.

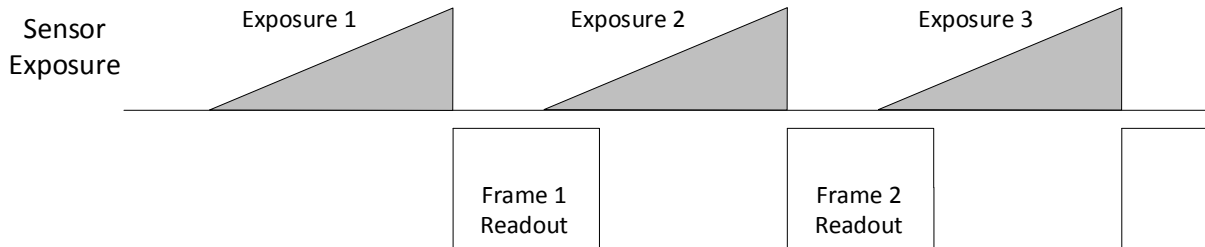

**Figure 8-7 Internal Trigger Overlap Exposure**

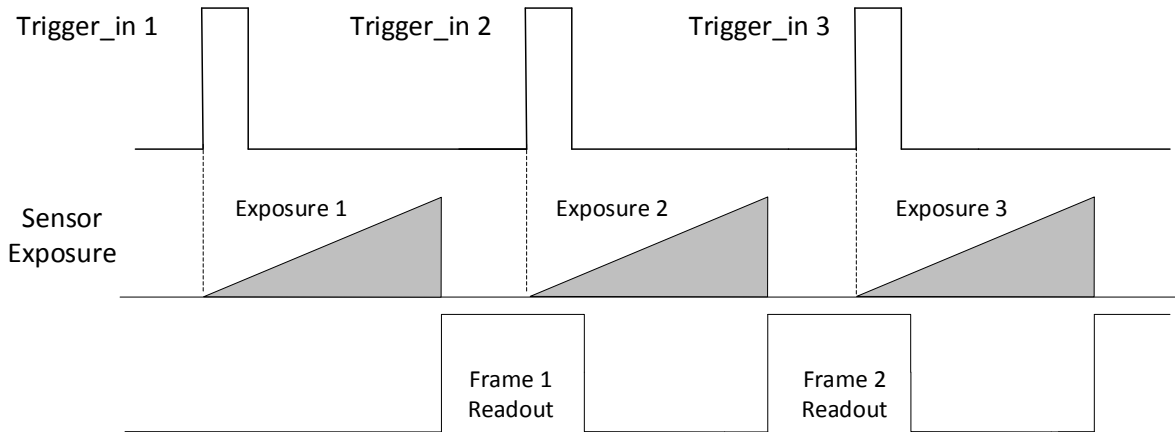

**Figure 8-8 External Trigger Overlap Exposure**

## Chapter 9 Image Acquisition

### 9.1 Set Frame Rate

#### Note

The image compression function may differ by device models

Frame rate refers to the image number that is acquired by the device per second. The higher frame rate, and shorter time used for image acquisition will be. The following five factors determine the device's frame rate in real-time.

- Frame readout time: The frame readout time is related with device's sensor performance and image height. The lower the image height and less the frame readout time, and the higher the frame rate will be.
- Exposure time: If the reciprocal of max. frame rate that the device supports is  $t$ , and when the configured exposure time is larger than  $t$ , the less the exposure time, the higher the frame rate will be. When the configured exposure time is less than or equal to  $t$ , exposure time will not influence the frame rate.
- Bandwidth: The larger the bandwidth, the higher the frame rate will be.
- Pixel format: The more bytes pixel format occupy, the lower the frame rate will be.
- Image compression mode: This function is used to compress data before transmitting to the PC, and increase the frame rate to some extent.

#### Steps

1. Go to **Acquisition Control** → **Acquisition Frame Rate**, and enter **Acquisition Frame Rate**.
2. Enable **Acquisition Frame Rate Control Enable**.

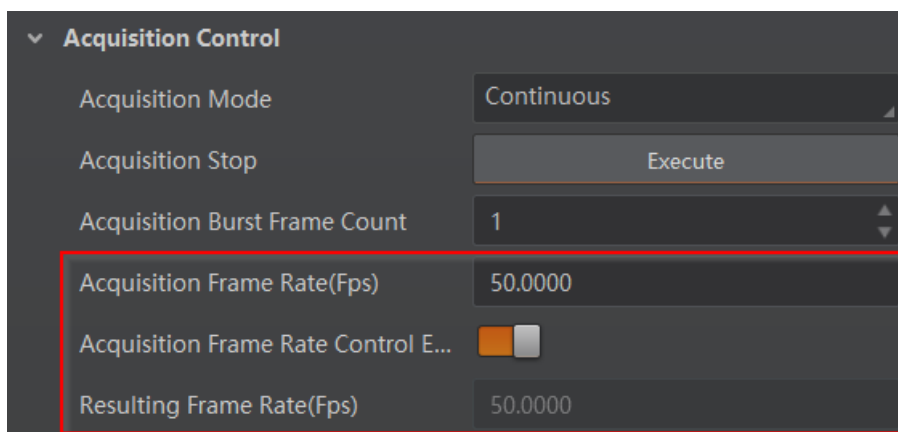
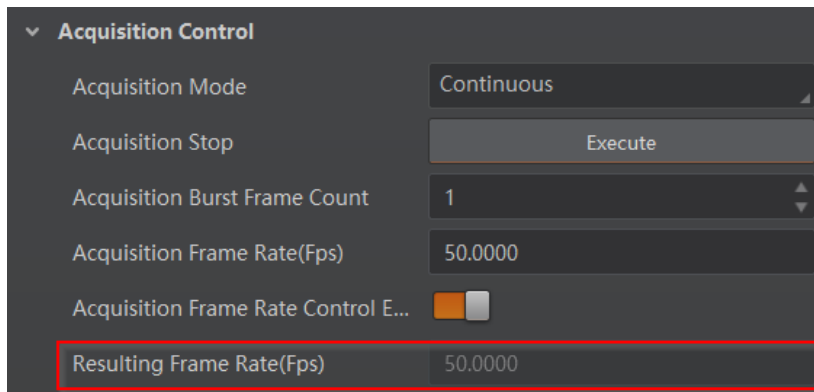

Figure 9-1 Set Frame Rate

## Note

- If the real-time frame rate is smaller than the value you set, the device acquires images by the real-time frame rate.
  - If the real-time frame rate is larger than the value you set, the device acquires images by the value you set.
- 

3. View the device's final frame rate in **Resulting Frame Rate**.



**Figure 9-2 View Resulting Frame Rate**

## 9.2 Set Full Frame Transmission

---

### Note

The full frame transmission function may differ by device models.

---

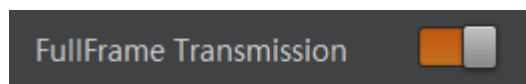

**Figure 9-3 Set Full Frame Transmission**

The full frame transmission function is used to continue frame transmission action and have a full frame when frame acquisition stops during the process, and the frame will be discarded if this parameter is not enabled.

Go to **Acquisition Control** → **Full Frame Transmission**, and enable it according to actual demands.

## 9.3 Set Overlap Mode

---

### Note

The overlap mode may differ by device models. Refer to section **Non-Overlap Exposure and Overlap Exposure** for detailed introduction.

---

The device's overlap function is controlled by the overlap mode. Go to **Acquisition Control** → **Overlap Mode**, select **On** as **Overlap Mode** to have overlap exposure, and select **Off** as **Overlap Mode** to have non-overlap exposure.

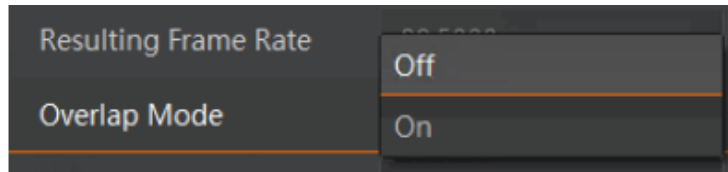

Figure 9-4 Set Overlap Mode

## 9.4 Set Acquisition Mode

The device supports two types of acquisition modes, including **SingleFrame** mode and **Continuous** mode. Go to **Acquisition Control** → **Acquisition Mode**, and select **Continuous** or **SingleFrame** as **Acquisition Mode** according to actual demands.

- **SingleFrame**: When device starts image acquisition, it acquires one image only, and then stops.
- **Continuous**: When device starts image acquisition, it acquires images continuously. Real-time frame rate decides the acquisition frame number per second. You can stop image acquisition manually.

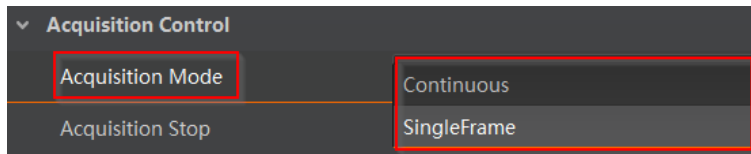

Figure 9-5 Set Acquisition Mode

## 9.5 Set Trigger Mode

The device supports two types of trigger modes, including internal trigger mode and external trigger mode. Go to **Scan Control** → **Trigger Control** → **Trigger Mode** and set it.

- **Internal Trigger Mode**: In this mode, the device acquires images via its internal signals.
- **External Trigger Mode**: In this mode, the device acquires images via external signals like software signal and hardware signal. The trigger source of external trigger mode includes software trigger, hardware trigger, counter trigger, action command trigger, and free trigger.

### 9.5.1 Enable Internal Trigger Mode

Go to **Acquisition Control** → **Trigger Mode**, and select **Off** as **Trigger Mode**.

**Note**

**Off** refers to the internal trigger mode.

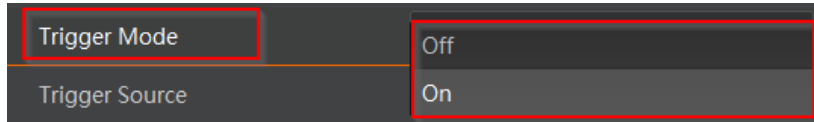

Figure 9-6 Enable Internal Trigger Mode

### 9.5.2 Enable External Trigger Mode

Go to **Acquisition Control** → **Trigger Mode**, and select **On** as **Trigger Mode**.

**Note**

**On** refers to the external trigger mode.

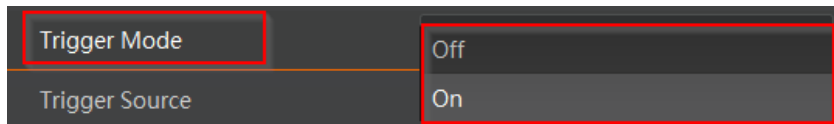

Figure 9-7 Enable External Trigger Mode

## 9.6 Set Trigger Source

The device’s trigger source includes software trigger, hardware trigger, counter trigger, action command trigger, and free trigger. Go to **Acquisition Control** → **Trigger Source**, and select **Trigger Source** according to actual demands.

Table 9-1 Trigger Source Description

Trigger Source	Parameter	Description
Software Trigger	Software	The software sends trigger signal to the device via GigE interface to acquire images.
Hardware Trigger	Line 0, Line 2	External device connects device via device I/O interface. External device sends trigger signal to device to acquire images.
Counter Trigger	Counter 0	The counter sends trigger signal to the device to acquire images.

Trigger Source	Parameter	Description
Action Command Trigger	Action 1	The action command sends trigger signal to the device to acquire images.
Free Trigger	Anyway	The device can receive software trigger and hardware trigger to acquire images.

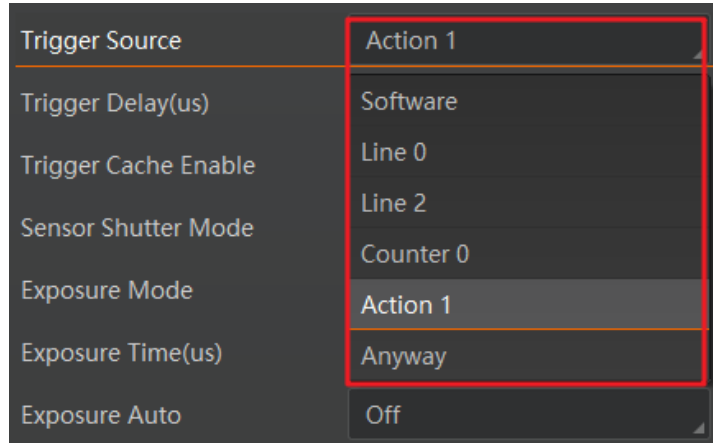

Figure 9-8 Set Trigger Source

**Note**

These five external trigger sources are valid only when the **Trigger Mode** is **On**.

### 9.6.1 Set and Execute Software Trigger

In software trigger, the software sends trigger signal to the device via GigE interface to acquire images.

**Steps**

1. Go to **Acquisition Control** → **Trigger Mode**, and select **On** as **Trigger Mode**.
2. Select **Software** as **Trigger Source**.
3. Click **Execute** in **Trigger Software**.

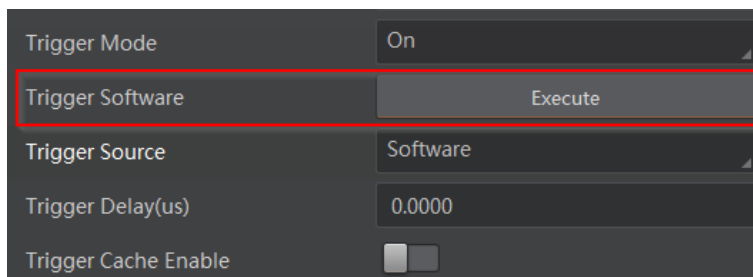

Figure 9-9 Set and Execute Software Trigger

### 9.6.2 Set and Execute Hardware Trigger

The device has one opto-isolated input (Line 0), and one bi-directional I/O (Line 2) that can be configured as input signal. The steps for configuring Line 2 as input signal as follows.

#### Steps

1. Go to **Digital IO Control** and select **Line 2** as **Line Selector**.
2. Select **Input** as **Line Mode**.

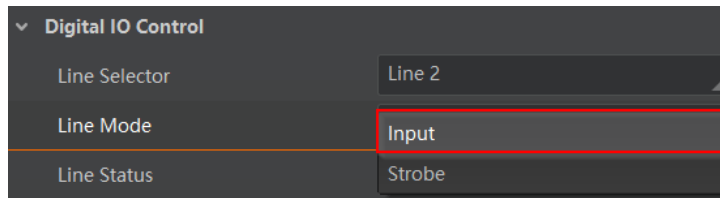
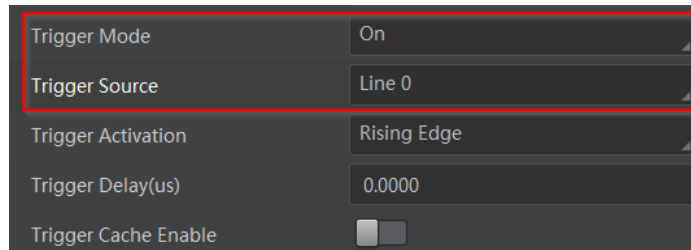

**Figure 9-10 Set Line 2 as Input Signal**

In hardware trigger, external device sends trigger signal to the device to acquire images via I/O connector.

#### Steps

1. Go to **Acquisition Control** → **Trigger Mode**, and select **On** as **Trigger Mode**.
2. Select **Line 0** or **Line 2** as **Trigger Source** according to actual demands.



**Figure 9-11 Set and Execute Hardware Trigger**

### 9.6.3 Set and Execute Counter Trigger

In counter trigger, the counter sends trigger signal to the device to acquire images.

#### Steps

1. Go to **Acquisition Control** → **Trigger Mode**, and select **On** as **Trigger Mode**.
2. Select **Counter 0** as **Trigger Source**.



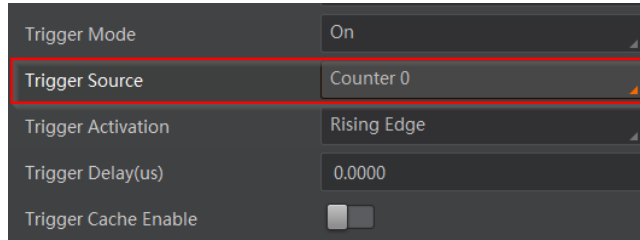
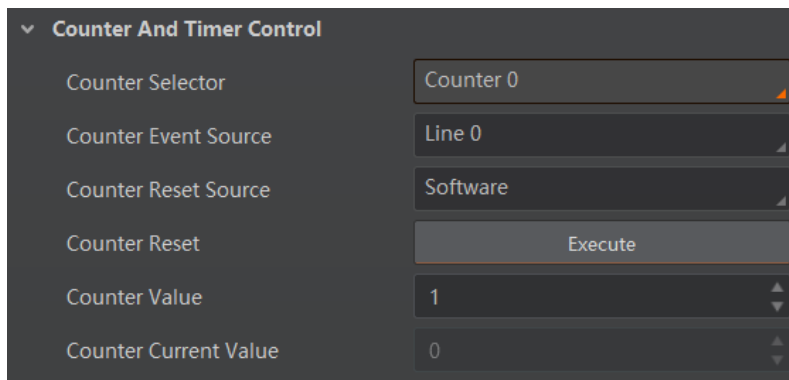

**Figure 9-12 Set and Execute Counter Trigger**

When using counter trigger, you need to set parameters of **Counter** and **Timer Control** as shown below.

**Table 9-2 Parameters of Counter and Timer Control**

Parameter	Read/Write	Description
Counter Selector	Read & Write	It selects counter source. <b>Counter 0</b> is available only at present.
Counter Event Source	Read & Write	It selects the signal source of counter trigger. <b>Line 0</b> or <b>Line 2</b> is available. This parameter is disabled by default.
Counter Reset Source	Read & Write	It selects the signal source of resetting counter. <b>Software</b> is available only. This parameter is disabled by default.
Counter Reset	Write is available under certain condition	It resets counter and it can be executed only when selecting <b>Software</b> as <b>Counter Reset Source</b> .
Counter Value	Read & Write	It is the counter value with the range of 1 to 1023.
Counter Current Value	Read Only	It displays the number of executed external trigger.



**Figure 9-13 Counter and Timer Control**

### 9.6.4 Set and Execute Action Command Trigger

When you need to use the function of action commands, you should set action command trigger first. The action command sends trigger signal to the device to acquire images.

#### Steps

1. Go to **Acquisition Control** → **Trigger Mode**, and select **On** as **Trigger Mode**.
2. Select **Action 1** as **Trigger Source**.

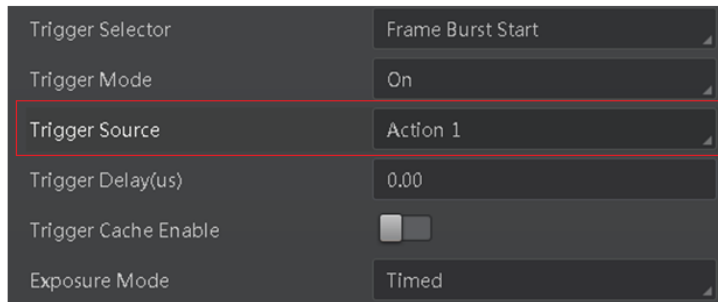

Figure 9-14 Set and Execute Action Command Trigger

---

#### Note

For specific function of action commands, please refer to the section **Set Action Command** for details.

---

### 9.6.5 Set and Execute Free Trigger

In free trigger, the device can receive software trigger and hardware trigger to acquire images.

#### Steps

1. Go to **Acquisition Control** → **Trigger Mode**, and select **On** as **Trigger Mode**.
2. Select **Anyway** as **Trigger Source**.

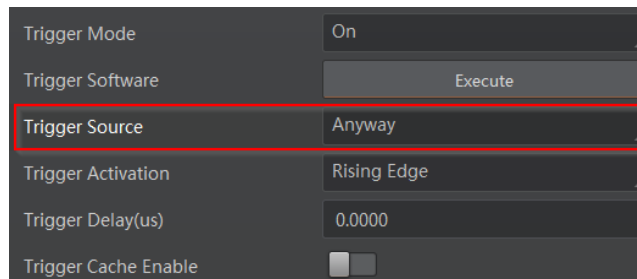

Figure 9-15 Set and Execute Free Trigger

## 9.7 Set Trigger Related Parameters

In external trigger mode, you can set five related parameters, including acquisition burst frame count, trigger activation, trigger delay, trigger cache, and trigger debouncer.

### Note

- Different trigger sources can set various parameters in external trigger mode.
- In hardware, counter or free trigger, you can set all five parameters mentioned above.
- In software or action command trigger, you can set acquisition burst frame count, trigger delay, and trigger cache only.

### 9.7.1 Set Acquisition Burst Frame Count

In external trigger mode, you can set acquisition burst frame count. Go to **Acquisition Control** → **Acquisition Burst Frame Count**, and enter **Acquisition Burst Frame Count** according to actual demands.

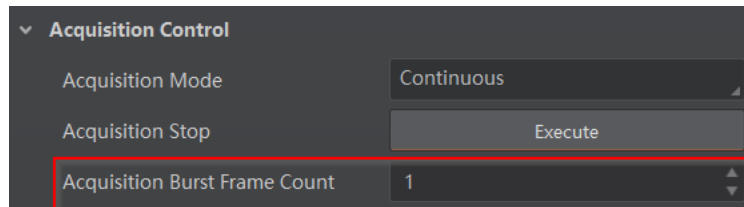

Figure 9-16 Set Acquisition Burst Frame Count

### Note

- The range of **Acquisition Burst Frame Count** is from 1 to 1023.
- If **Acquisition Burst Frame Count** is 1, the device is in single frame trigger mode. If **Acquisition Burst Frame Count** is larger than 1, the device is in multi-frame trigger mode.
- If **Acquisition Burst Frame Count** is  $n$ , when input 1 trigger signal to the device, the device stops acquiring images after exposing  $n$  times and outputting  $n$  frame images.

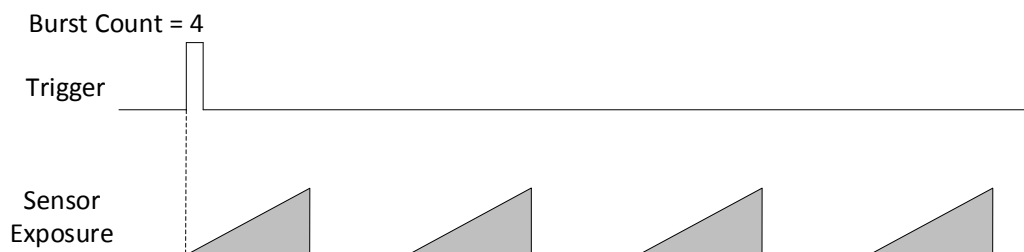

Figure 9-17 Sequence Diagram of Acquisition Burst Frame Count

### 9.7.2 Set Trigger Activation

The device supports triggering image acquisition in the rising edge, falling edge, level high, level low or any edge of the external signal. Go to **Acquisition Control** → **Trigger Activation**, and select **Rising Edge**, **Falling Edge**, **Level High** or **Level Low** as **Trigger Activation**.

- **Rising Edge**: It means that when the level signal sent by external device is in rising edge, the device receives trigger signal and starts to acquire images.
- **Falling Edge**: It means that when the level signal sent by external device is in falling edge, the device receives trigger signal and starts to acquire images.
- **Level High**: The level high of the trigger signal is valid. As long as the trigger signal is in level high, the device is in image acquisition status.
- **Level Low**: The level low of the trigger signal is valid. As long as the trigger signal is in level low, the device is in image acquisition status.

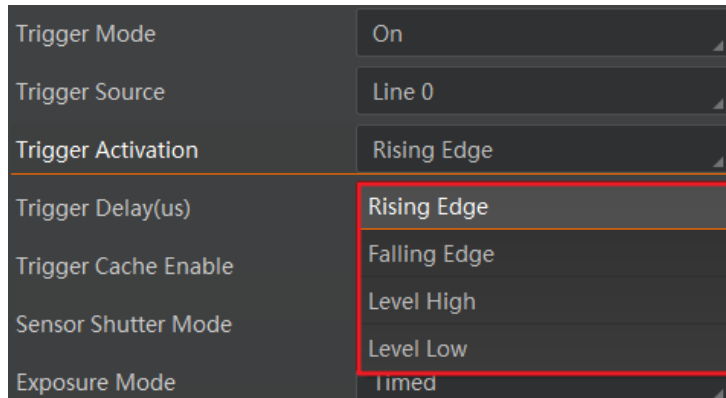

Figure 9-18 Set Trigger Activation

### 9.7.3 Set Trigger Delay

The trigger delay function allows the device to add a delay between the receipt of trigger signal and the moment the trigger becomes active. Go to **Acquisition Control** → **Trigger Delay**, and enter **Trigger Delay**, and the unit is  $\mu\text{s}$ .

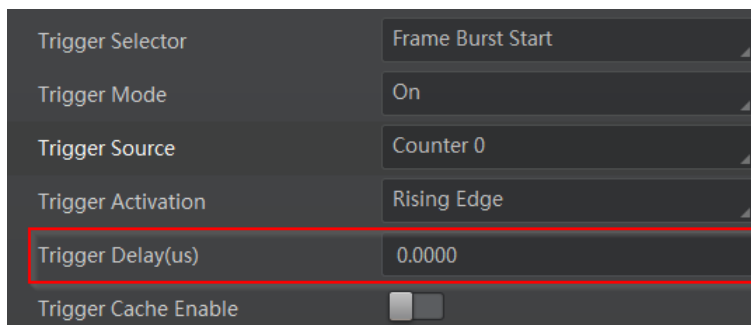

Figure 9-19 Set Trigger Delay

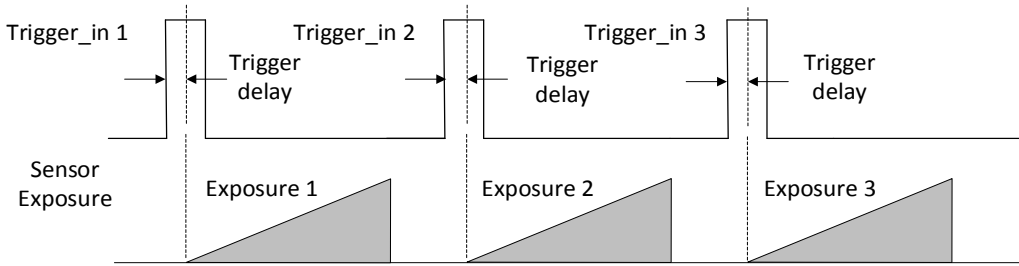

Figure 9-20 Sequence Diagram of Trigger Delay

### 9.7.4 Set Trigger Cache

The trigger cache function allows the device to save and process new signal during trigger stage, and the device can save and process three trigger signals at most. Go to **Acquisition Control** → **Trigger Cache Enable**, and enable **Trigger Cache Enable**.

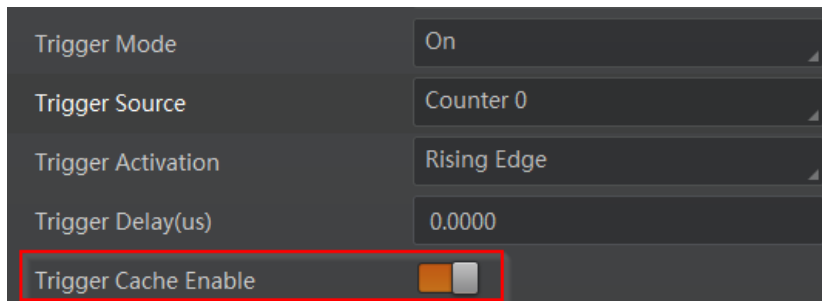

Figure 9-21 Set Trigger Cache

For example, if the device receives the 2nd trigger signal when it is processing the 1st trigger signal, and the result will be different depending on whether **Trigger Cache Enable** is enabled or not.

- The 2nd trigger signal will be filtered without processing if **Trigger Cache Enable** is disabled.

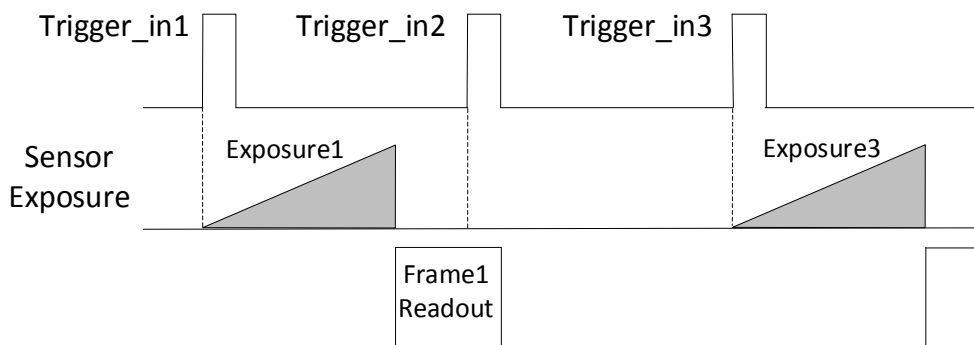
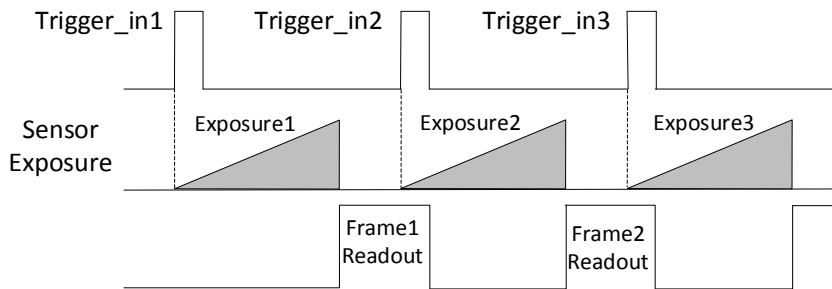

Figure 9-22 Second Frame Filtered

- The 2nd trigger signal will be saved if **Trigger Cache Enable** is enabled.

If the 1st frame image's exposure time of the 2nd trigger signal is not earlier than the device's last frame creation time of the 1st trigger signal, and then the 2nd trigger signal's 1st frame image is created normally.



**Figure 9-23 Second Frame Created Normally**

If the 1st frame image's exposure time of the 2nd trigger signal is earlier than the device's last frame creation time of the 1st trigger signal, and then the device will delay this exposure time. Thus making sure this exposure time is not earlier than the device's last frame creation time of the 1st trigger signal.

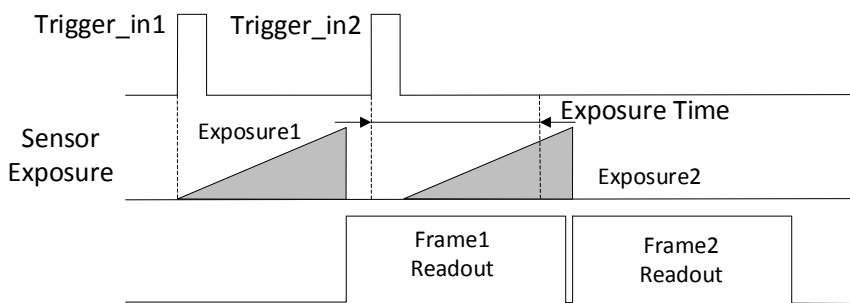

**Figure 9-24 Sequence Diagram**

## Note

The three sequence diagrams above use rising edge as trigger activation.

## 9.7.5 Set Trigger Debouncer

The trigger debouncer function allows the device to filter out unwanted short external trigger signal that is input to the device.

Go to **Digital IO Control** → **Line Debouncer Time**, and enter **Line Debouncer Time** according to actual demands. The range of **Line Debouncer Time** is from 0  $\mu\text{s}$  to 1000000  $\mu\text{s}$ .

## Note

If the **Line Debouncer Time** you set is greater than the time of trigger signal, this trigger signal will be ignored.

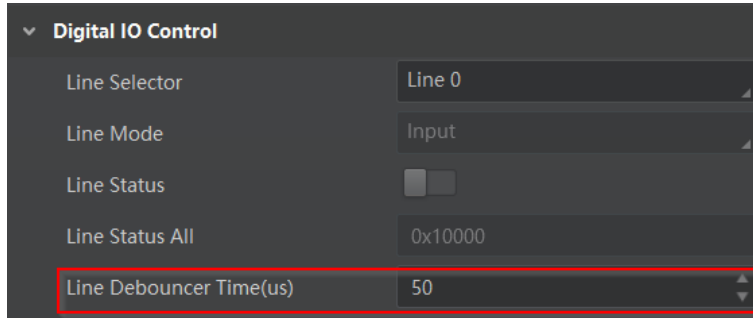

**Figure 9-25 Set Trigger Debouncer**

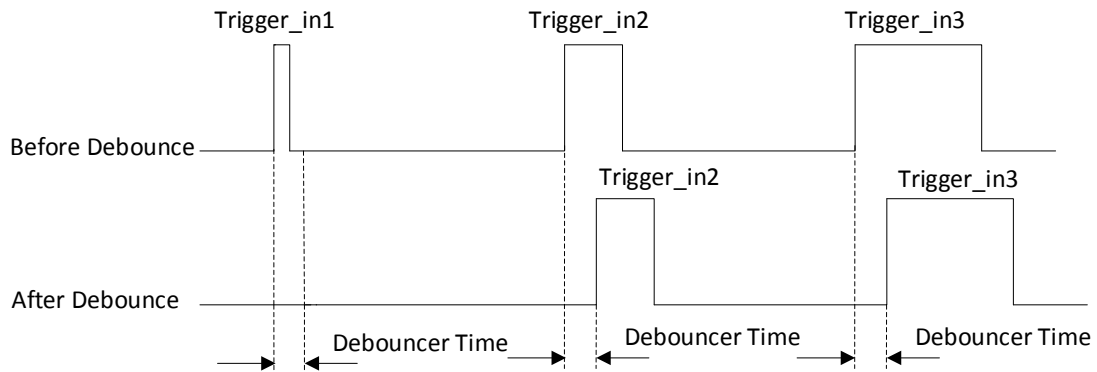

**Figure 9-26 Sequence Diagram of Trigger Debouncer**

**Note**

The sequence diagrams above use rising edge as trigger activation.

## Chapter 10 Trigger Output

### 10.1 Select Output Signal

The device has one opto-isolated output (Line 1), and one bi-directional I/O (Line 2) that can be configured as output signal. The steps for configuring Line 2 as output signal as follows.

#### Steps

1. Go to **Digital IO Control** and select **Line 2** as **Line Selector**.
2. Select **Strobe** as **Line Mode**.

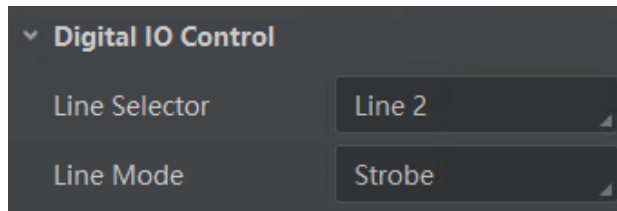

Figure 10-1 Set Line 2 as Output Signal

### 10.2 Set Output Signal

The output signal of the device is switch signal that can be used to control external devices such as light source, PLC, etc. There are two ways to set output signal, including line inverter and strobe signal.

#### 10.2.1 Enable Line Inverter

The line inverter function allows the device to invert the electrical signal level of an I/O line. Go to **Digital IO Control** → **Line Inverter**, and enable it.

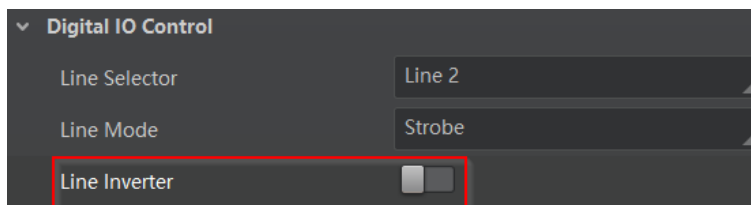

Figure 10-2 Enable Line Inverter

---

#### Note

The line inverter function is disabled by default.

---



## 10.2.2 Enable Strobe Signal

The strobe signal is used to directly output I/O signal to external devices when the device's event source occurs.

### Steps

1. Go to **Digital IO Control** → **Line Source**, and select **Line Source** according to actual demands.
2. Enable **Strobe Enable**.

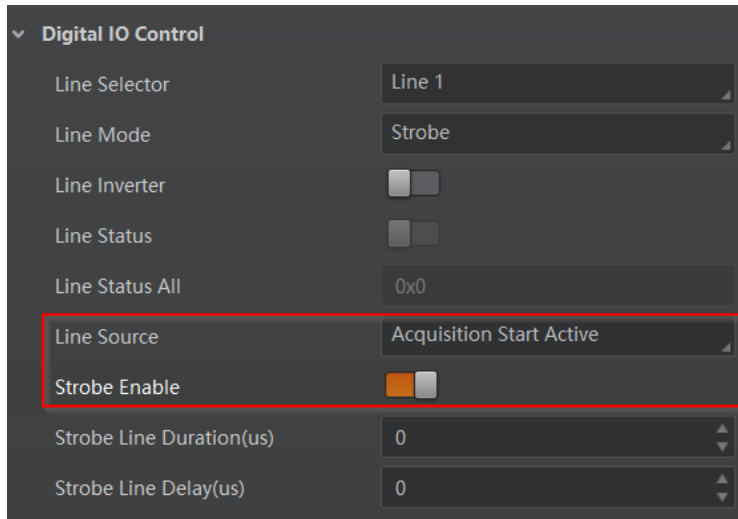

**Figure 10-3 Enable Strobe Signal**

The supported line sources are as follows:

**Table 10-1 Line Source Description**

Line Source	Description
Exposure Start Active	The device outputs signals to external devices when it starts exposure.
Exposure End Active	The device outputs signals to external devices when it stops exposure.
Acquisition Start Active	The device outputs signals to external devices when it starts acquiring images.
Acquisition Stop Active	The device outputs signals to external devices when it stops acquiring images.
Frame Burst Start Active	The device outputs signals to external devices when the device's frame burst starts.
Frame Burst End Active	The device outputs signals to external devices when the device's frame burst stops.
Frame Trigger Wait	The device is currently waiting for a frame start trigger.

Line Source	Description
Frame Start Active	The device outputs signals to external devices when it starts doing the capture of a frame.
Frame End Active	The device outputs signals to external devices when it stops doing the capture of a frame.
Soft Trigger Active	The device outputs signals to external devices when it has a software trigger.
Hard Trigger Active	The device outputs signals to external devices when it has a hardware trigger.
Counter Active	The device outputs signals to external devices when it has a counter trigger.
Timer Active	The device outputs signals to external devices when it has a timer trigger.

**Note**

The specific line sources may differ by device models.

If **Timer Active** is selected as **Line Source**, you can click **Execute** in **Line Trigger Software**, and enter **Strobe Line Delay** according to actual demands. The device will output signals whose duration is configured in **Strobe Line Duration**.

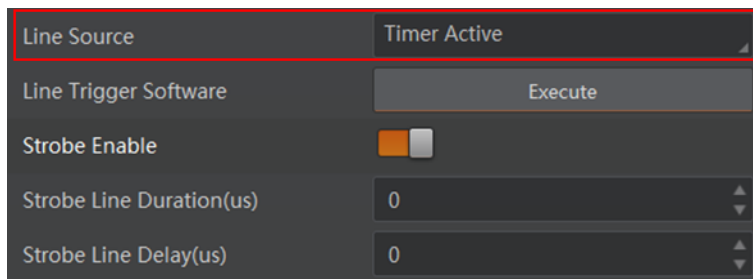

**Figure 10-4 Timer Active Parameters**

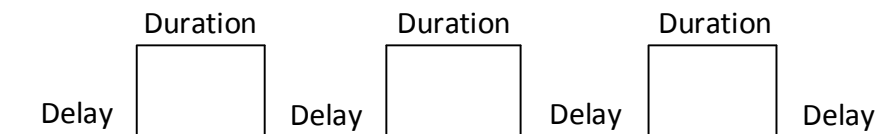

**Figure 10-5 Sequence Diagram of Timer Active**

### Set Strobe Line Duration

After enabling strobe signal, you can set its duration. Go to **Digital IO Control** → **Strobe Line Duration**, and enter it according to actual demands.



Figure 10-6 Set Strobe Line Duration

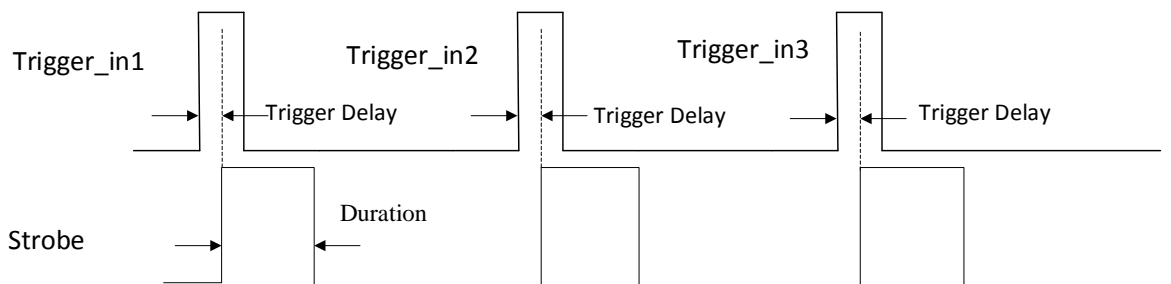

Figure 10-7 Sequence Diagram of Strobe Line Duration

#### Note

When the **Strobe Line Duration** value is 0, the strobe duration is equal to the exposure time. When the **Strobe Line Duration** value is not 0, the strobe duration is the configured value you set.

### Set Strobe Line Delay

The strobe line delay function allows the device to output signal in a delay time. Go to **Digital IO Control** → **Strobe Line Delay**, and enter it according to actual demands. The range of **Strobe Line Delay** is from 0  $\mu$ s to 10000  $\mu$ s.

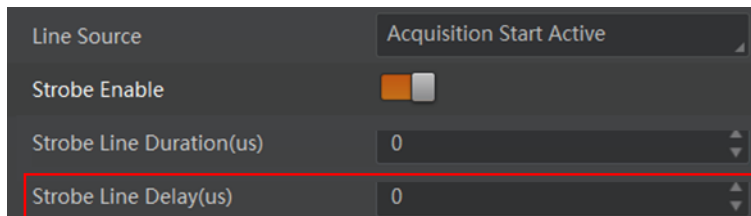

Figure 10-8 Set Strobe Line Delay

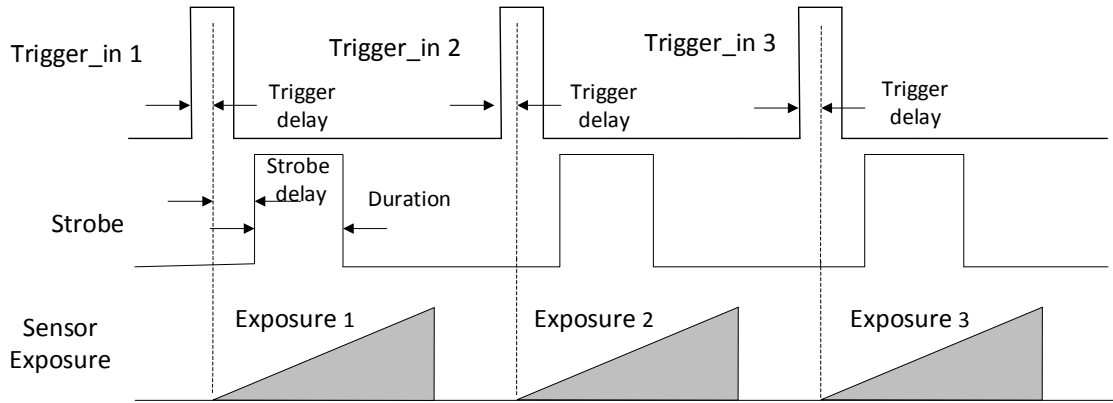

Figure 10-9 Sequence Diagram of Strobe Line Delay

### Set Strobe Line Pre Delay

The device also supports the function of strobe line pre delay, which means that the strobe signal takes effect early than exposure. This function is applied to the external devices that have slow response speed.

Click **Digital IO Control** → **Strobe Line Pre Delay**, and enter **Strobe Line Pre Delay** according to actual demands.

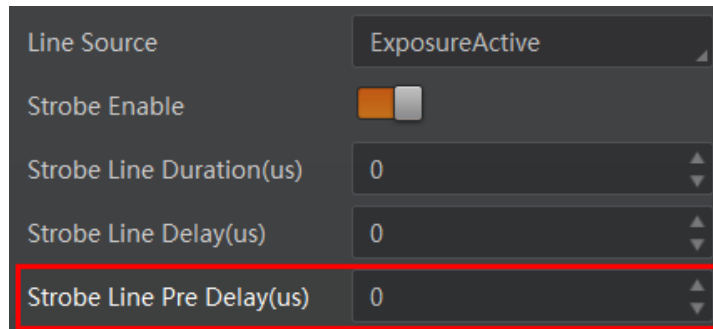

Figure 10-10 Set Strobe Pre Line Delay

The sequence diagram of strobe line pre delay is shown below.

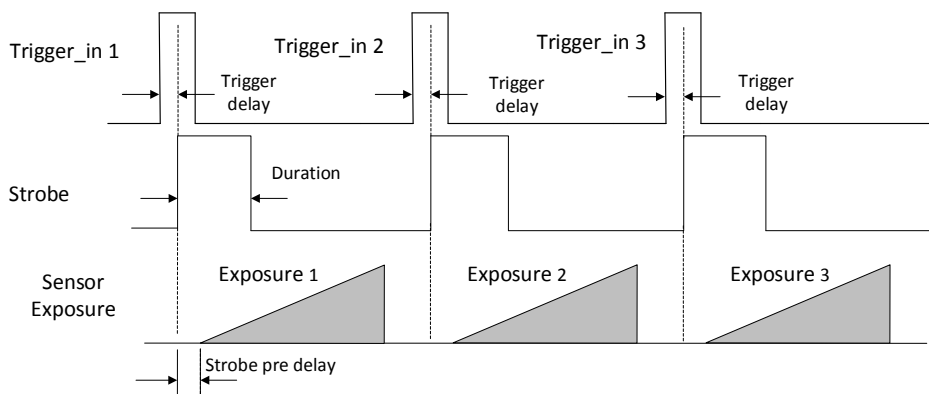

Figure 10-11 Sequence Diagram of Strobe Pre Line Delay

# Chapter 11 I/O Electrical Features and Wiring

## 11.1 I/O Electrical Features

### 11.1.1 Electrical Features of Input Signal

The internal circuit of opto-isolated input (Line 0) is as follows.

#### Note

- The maximum input current of Line 0 is 25 mA.
- Make sure that the input voltage is not from 1 VDC to 3.3 VDC as the electric status between these two values are not stable.
- The breakdown voltage is 30 VDC. Keep voltage stable.

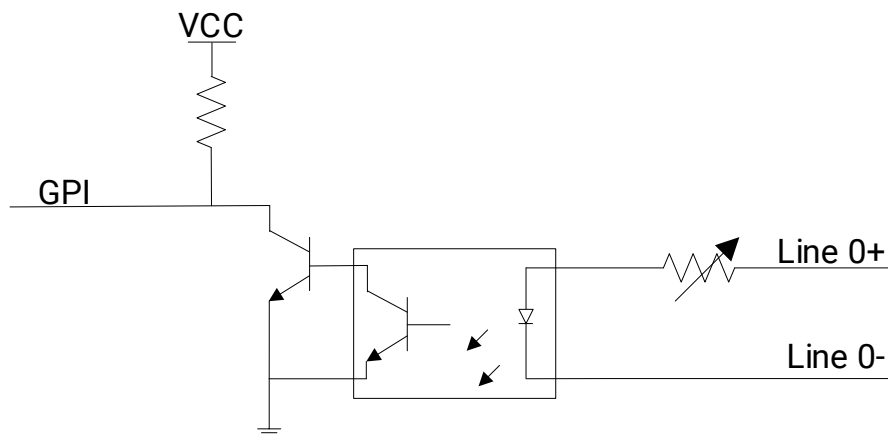

Figure 11-1 Internal Circuit of Input Signal

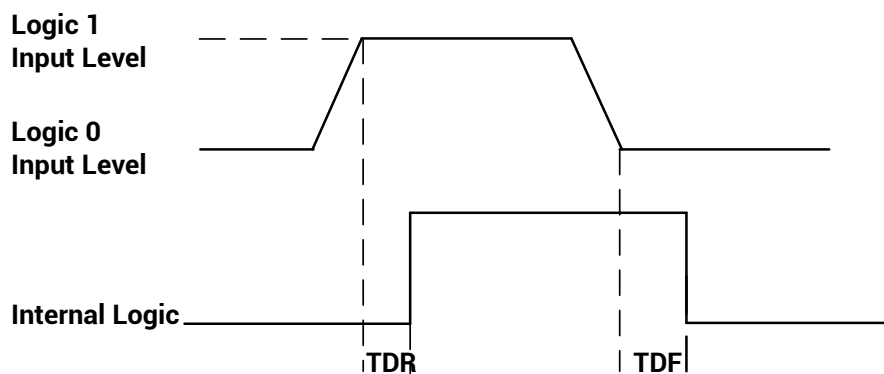

Figure 11-2 Input Logic Level

**Table 11-1 Input Electrical Feature**

Parameter Name	Parameter Symbol	Value
Input Logic Level Low	VL	0 VDC to 1 VDC
Input Logic Level High	VH	3.3 VDC to 24 VDC
Input Falling Delay	TDF	16.8 $\mu$ s to 22 $\mu$ s
Input Rising Delay	TDR	1.8 $\mu$ s to 4.6 $\mu$ s

### 11.1.2 Electrical Features of Output Signal

The internal circuit of opto-isolated output (Line 1) is as follows.

**Note**

The maximum output current of Line 1 is 25 mA.

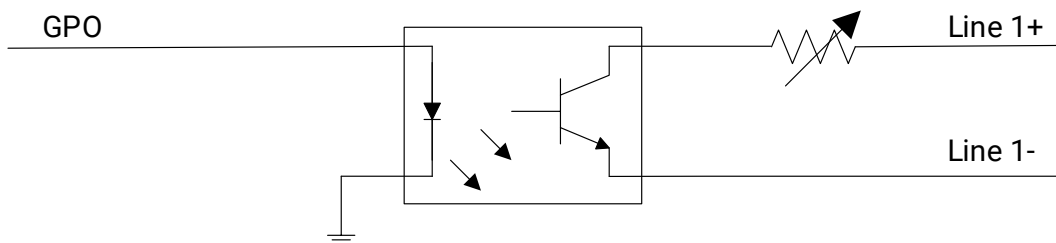

**Figure 11-3 Internal Circuit of Output Signal**

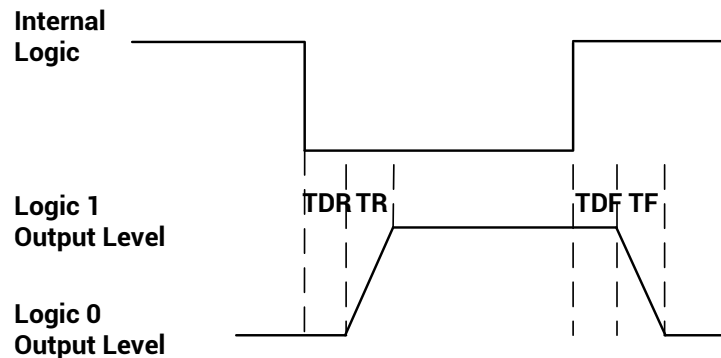

**Figure 11-4 Output Logic Level**

The electrical features of opto-isolated output when the external voltage is 3.3 VDC and the external resistance is 1 KΩ is shown below.

**Table 11-2 Output Electrical Feature**

Parameter Name	Parameter Symbol	Value
Output Logic Level Low	VL	575 mV
Output Logic Level High	VH	3.3 VDC
Output Rising Time	TR	8.4 μs
Output Falling Time	TF	1.9 μs
Output Rising Delay	TDR	15 μs to 60 μs
Output Falling Delay	TDF	3 μs to 6 μs

With different external voltage and resistance, the corresponding current and the parameter of output logic level low are shown below.

**Table 11-3 Parameters of Output Logic Level Low**

External Voltage	External Resistance	VL	Output Current
3.3 VDC	1 KΩ	575 mV	2.7 mA
5 VDC	1 KΩ	840 mV	4.1 mA
12 VDC	2.4 KΩ	915 mV	4.6 mA
24 VDC	4.7 KΩ	975 mV	4.9 mA

### 11.1.3 Electrical Features of Bi-Directional Signal

The device has one bi-directional non-isolated I/O signal (Line 2), and you can set it as input signal or output signal according to demands. Its internal circuit is as follows.

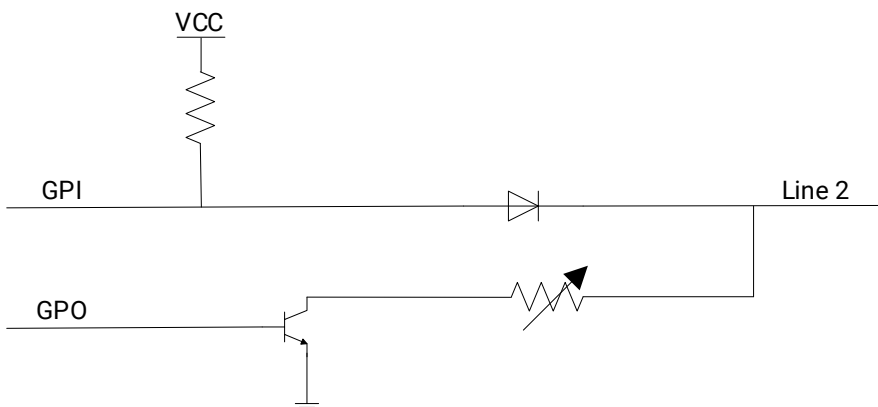

**Figure 11-5 Internal Circuit of Bi-Directional Signal**

## Configured as Input Signal

### Note

- Make sure that the input voltage is not from 0.3 VDC to 3.3 VDC as the electric status between these two values are not stable.
- The breakdown voltage is 30 VDC. Keep voltage stable.
- To prevent damage to the GPIO pin, please connect GND first and then input voltage in Line 2.

With the condition of 100  $\Omega$  resistance and 5 VDC voltage, the logic level and electrical feature of configuring Line 2 as input signal are shown below.

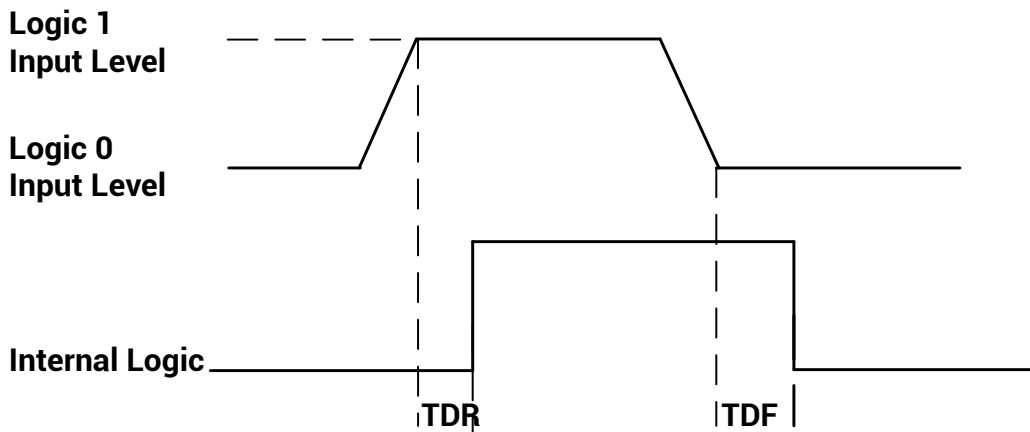

Figure 11-6 Input Logic Level

Table 11-4 Input Electrical Feature

Parameter Name	Parameter Symbol	Value
Input Logic Level Low	VL	0 VDC to 0.3 VDC
Input Logic Level High	VH	3.3 VDC to 24 VDC
Input Falling Delay	TDF	< 1 $\mu$ s
Input Rising Delay	TDR	< 1 $\mu$ s

## Configured as Output Signal

### Note

The maximum current is 25 mA and the output impedance is 40  $\Omega$ .



The relation among external voltage, resistance and the output level low is shown below.

**Table 11-5 Parameters of Output Logic Level Low**

External Voltage	External Resistance	VL (GPIO2)
3.3 VDC	1 K $\Omega$	160 mV
5 VDC	1 K $\Omega$	220 mV
12 VDC	1 K $\Omega$	460 mV
24 VDC	1 K $\Omega$	860 mV
30 VDC	1 K $\Omega$	970 mV

When the voltage of external resistance (1 K $\Omega$ ) is pulled up to 5 VDC, the logic level and electrical feature of configuring Line 2 as output are shown below.

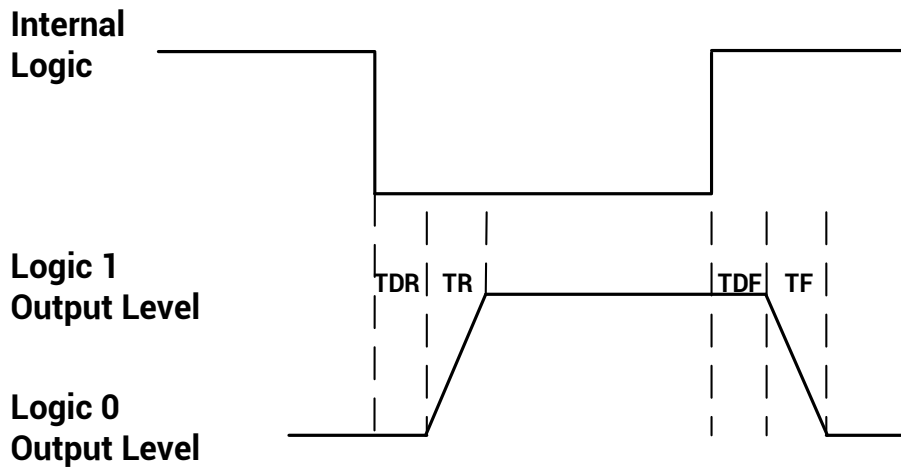

**Figure 11-7 Output Logic Level**

**Table 11-6 Output Electrical Feature**

Parameter Name	Parameter Symbol	Value
Output Logic Level Low	VL	220 mV
Output Logic Level High	VH	4.75 VDC
Output Rising Time	TR	0.06 $\mu$ s
Output Falling Time	TF	0.016 $\mu$ s
Output Rising Delay	TDR	0 $\mu$ s to 4 $\mu$ s
Output Falling Delay	TDF	< 1 $\mu$ s

## 11.2 I/O Wiring

This section introduces how to wire the device via its I/O connector.

### Note

Here we take one kind of device as an example to introduce I/O wiring. The appearance here is for reference only, and the actual device you purchased shall prevail.

### 11.2.1 Input Signal Wiring

The input signal wiring is shown below when the device uses Line 0 as trigger source in external trigger mode.

### Note

Input signal wiring may differ by the external device type.

#### PNP Device

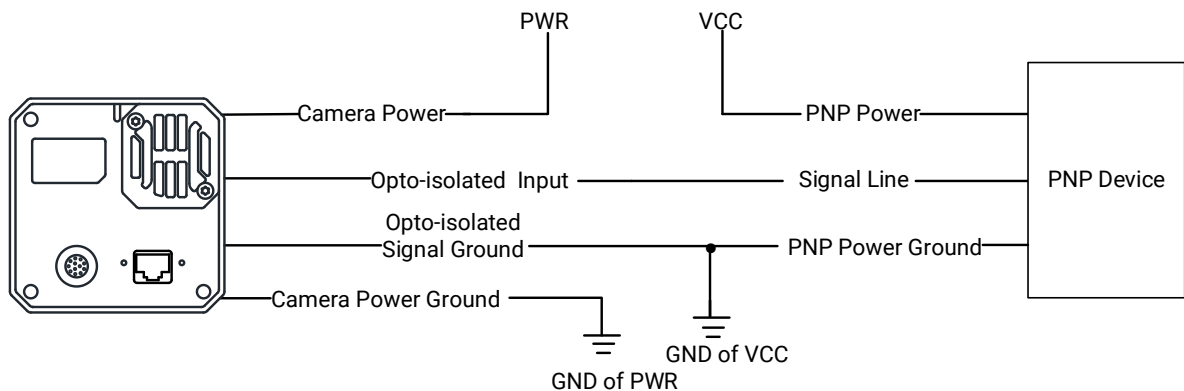
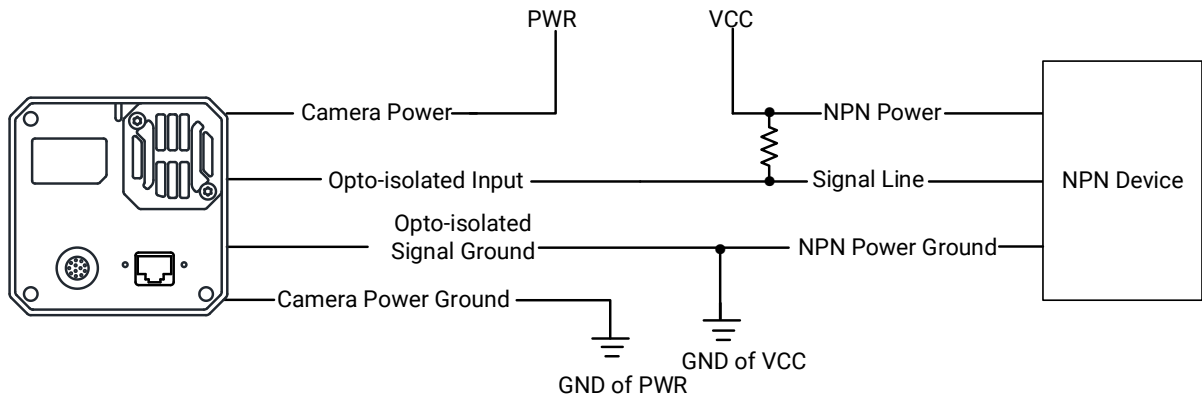

Figure 11-8 Input Signal Connects to PNP Device

#### NPN Device

- If the VCC of NPN device is 24 VDC, it is recommended to use 4.7 K $\Omega$  pull-up resistor.
- If the VCC of NPN device is 12 VDC, it is recommended to use 1 K $\Omega$  pull-up resistor.



**Figure 11-9 Input Signal Connects to NPN Device**

## Switch

If the VCC of switch is 24 VDC, it is recommended to use 4.7 K $\Omega$  resistor to protect circuit.

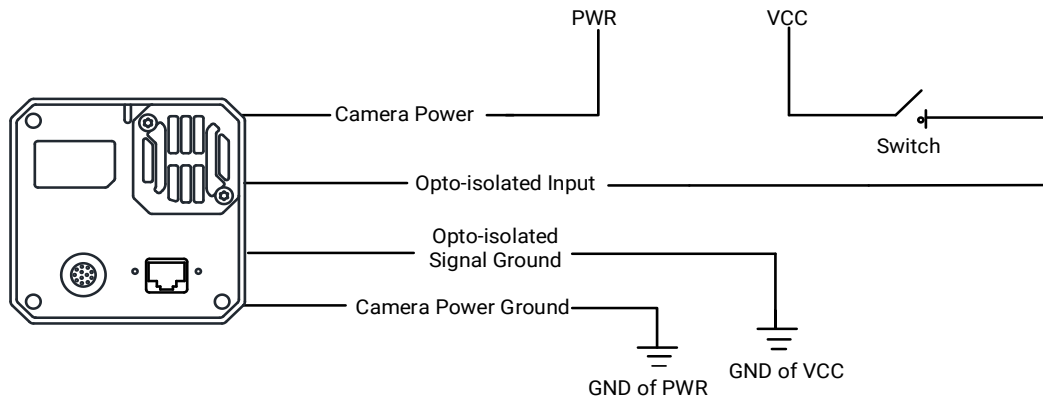

**Figure 11-10 Input Signal Connects to Switch**

## 11.2.2 Output Signal Wiring

The output signal wiring is shown below when the device uses Line 1 as output signal.

### Note

Output signal wiring may differ by the external device type.

### PNP Device

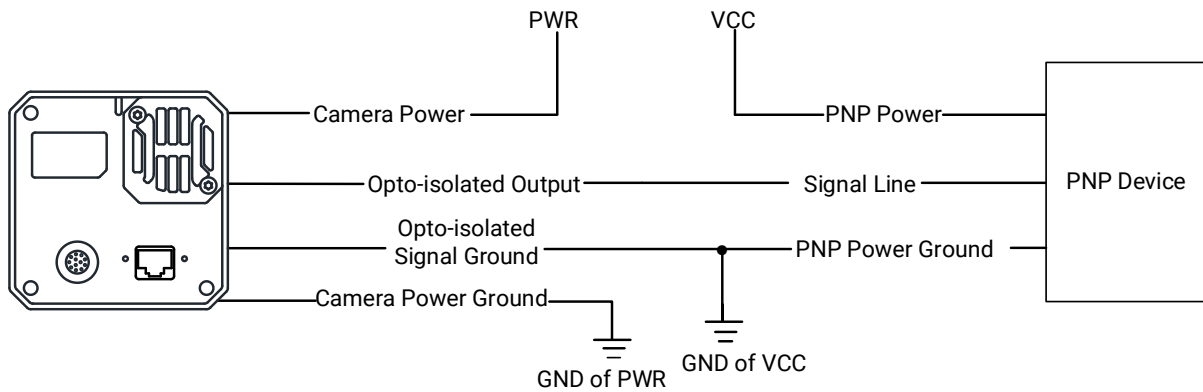

Figure 11-11 Output Signal Connects to PNP Device

### NPN Device

- If the VCC of NPN device is 24 VDC, it is recommended to use 4.7 K $\Omega$  pull-up resistor.
- If the VCC of NPN device is 12 VDC, it is recommended to use 1 K $\Omega$  pull-up resistor.

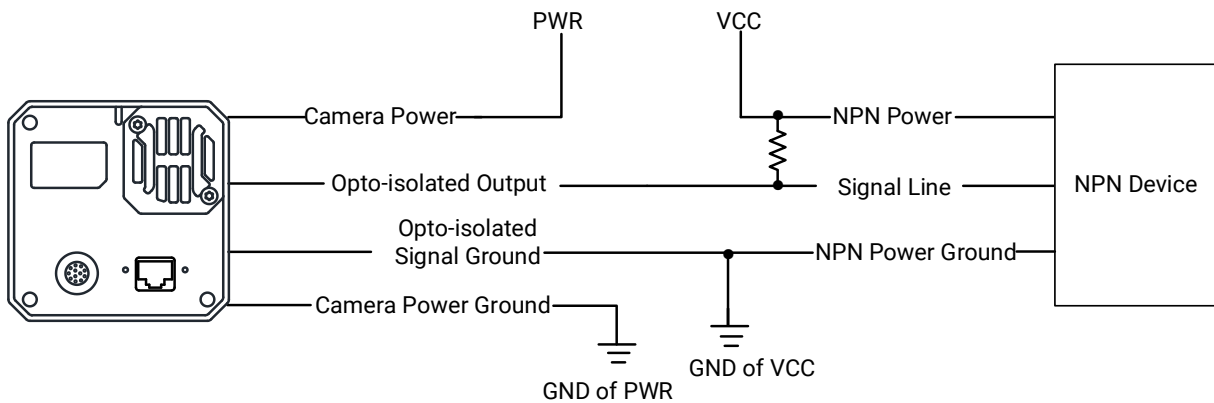

Figure 11-12 Output Signal Connects to NPN Device

## 11.2.3 Bi-Directional Signal Wiring

The device's Line 2 can be used as input signal and output signal.

### Configured as Input Signal

The input signal wiring is shown below when the device's Line 2 is configured as input signal.

#### Note

Input signal wiring may differ by the external device type.

## PNP Device

It is recommended to use 330  $\Omega$  pull-down resistor.

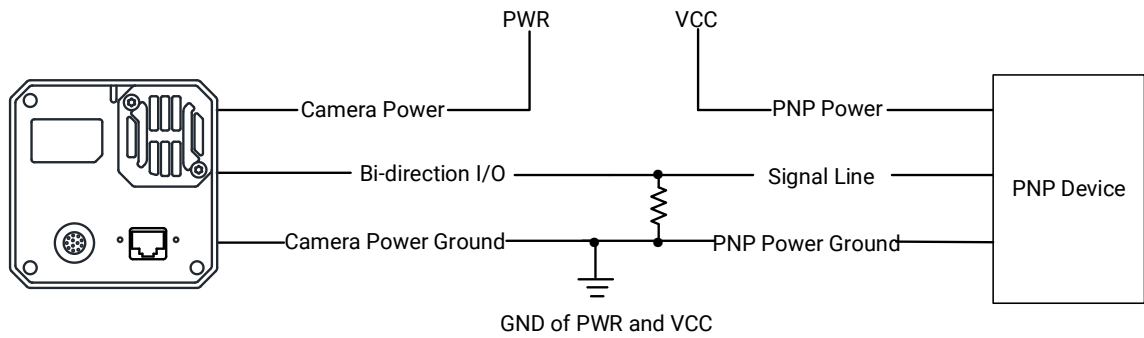

**Figure 11-13 Input Signal Connects to PNP Device**

## NPN Device

- If the VCC of NPN device is 24 VDC, it is recommended to use 4.7 K $\Omega$  pull-up resistor.
- If the VCC of NPN device is 12 VDC, it is recommended to use 1 K $\Omega$  pull-up resistor.

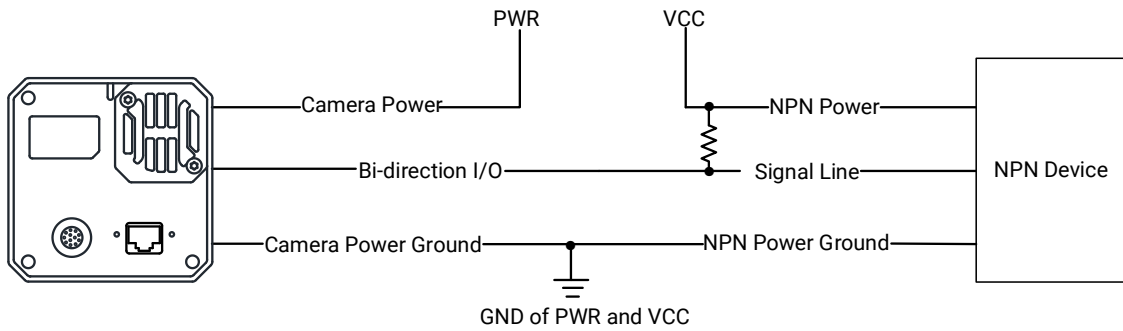

**Figure 11-14 Input Signal Connects to NPN Device**

## Switch

The switch value can provide low electrical level to trigger line 2.

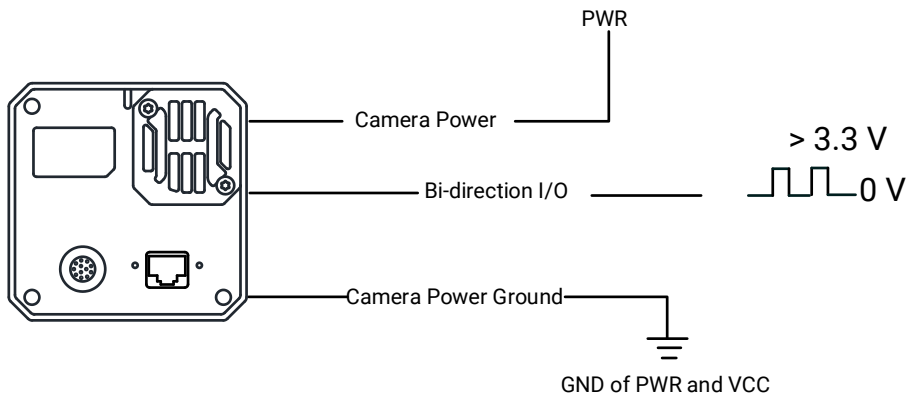

**Figure 11-15 Input Signal Connects to Switch**

## Configured as Output Signal

The output signal wiring is shown below when the device's Line 2 is configured as output signal.

### Note

Output signal wiring may differ by the external device type.

## PNP Device

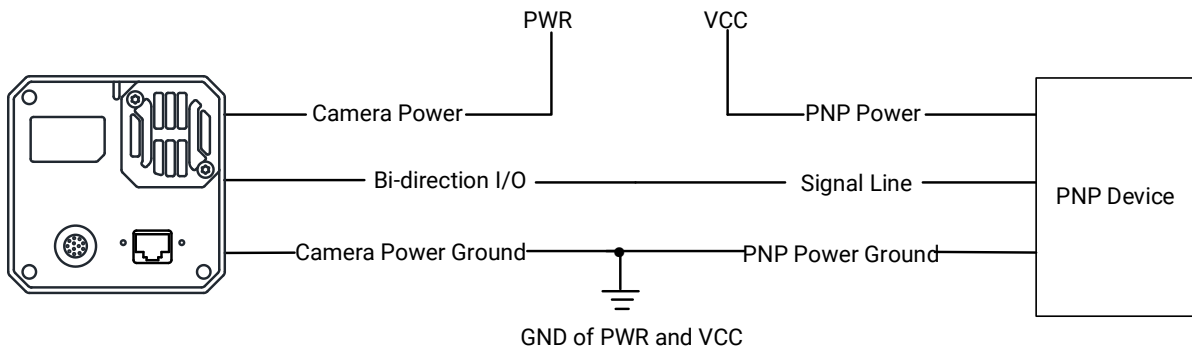

**Figure 11-16 Output Signal Connects to PNP Device**

## NPN Device

- If the VCC of NPN device is 24 VDC, it is recommended to use 4.7 KΩ pull-up resistor.
- If the VCC of NPN device is 12 VDC, it is recommended to use 1 KΩ pull-up resistor.

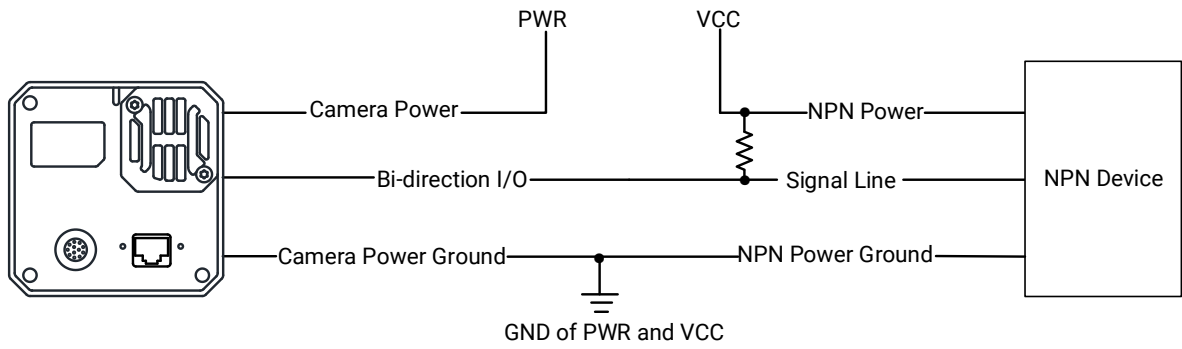

**Figure 11-17 Output Signal Connects to NPN Device**

## Chapter 12 Image Parameter

### 12.1 View Resolution

---

#### Note

The device displays the image with max. resolution by default.

---

Go to **Image Format Control**, and you can view resolution by reading **Width Max** and **Height Max**. **Width Max** stands for the max. pixels per inch in width direction, and **Height Max** stands for the max. pixels per inch in height direction.

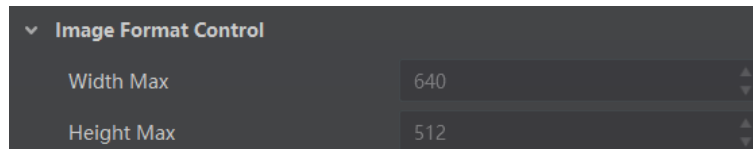

Figure 12-1 View Resolution

### 12.2 Set ROI

If you are only interested in a certain region of the image, you can set a Region of Interest (ROI) for the device.

---

#### Note

- The device currently supports one ROI only, and you can select **Region 0** as **Region Selector**.
  - Region of interest can be set only when you stop real-time acquisition.
- 

Go to **Image Format Control** → **Region Selector**, and enter **Width**, **Height**, **Offset X**, and **Offset Y**.

---

#### Note

The **Width** plus **Offset X** should not be larger than **Width Max**, and **Height** plus **Offset Y** should not be larger than **Height Max**.

---

- **Width**: It stands for horizontal resolution in ROI area.
- **Height**: It stands for vertical resolution in ROI area.
- **Offset X**: It refers to the horizontal coordinate of the upper left corner of the ROI.
- **Offset Y**: It refers to the vertical coordinate of the upper left corner of the ROI.



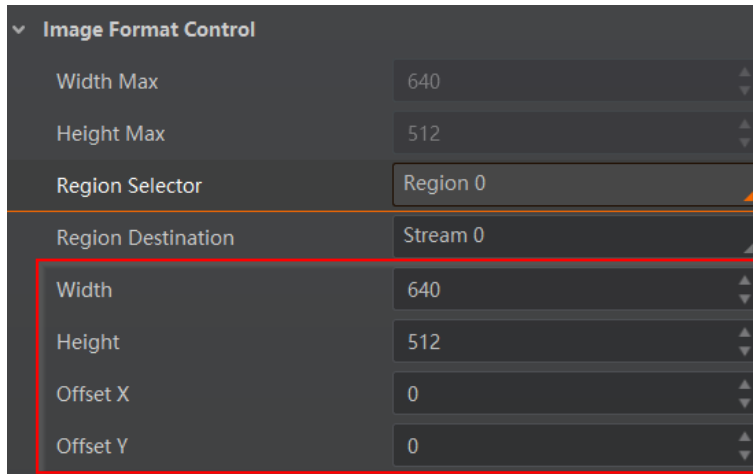

Figure 12-2 Set ROI

## 12.3 Set Image Reverse

### Note

- For different models of device, the image reverse function may be different, please refer to the actual one you got.
- Only when the device stops streaming, you can enable **Reverse Y**.

**Reverse X** refers to the image reverses in a horizontal way, and **Reverse Y** refers to the image reverses in a vertical way.

You can click **Image Format Control**, and enable **Reverse X** or **Reverse Y** according to actual demands.



Figure 12-3 Set Image Reverse

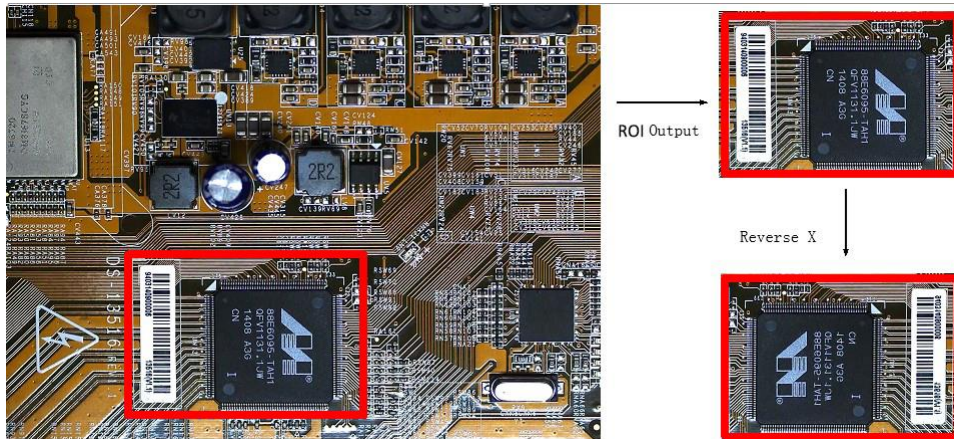

Figure 12-4 Image Reverse Comparison

## 12.4 Set Pixel Format

This function allows you to set the pixel format of the image data transmitted by the device. Go to **Image Format Control** → **Pixel Format**, and set **Pixel Format** according to actual demands.

### Note

- The specific pixel formats may differ by device models.
- With different ADC bit depth, the pixel format and pixel size may differ.

Table 12-1 Pixel Format and Pixel Size

ADC Bit Depth	Pixel Format	Pixel Size (Bits/Pixel)
8	Mono 8, Bayer 8	8
	Mono10 Packed, Mono 12 packed, Bayer 10 Packed, Bayer 12 Packed	12
	Mono 10/12 , Bayer 10/12, YUV422Packed, YUV 422 (YUYV) Packed	16
	RGB 8, BGR 8	24
12	Mono 8, Bayer 8	8
	Mono10 Packed, Mono 12 packed, Bayer 10 Packed, Bayer 12 Packed	12
	Mono 10/12, Bayer 10/12, YUV422Packed, YUV 422 (YUYV) Packed	16
	RGB 8, BGR 8	24

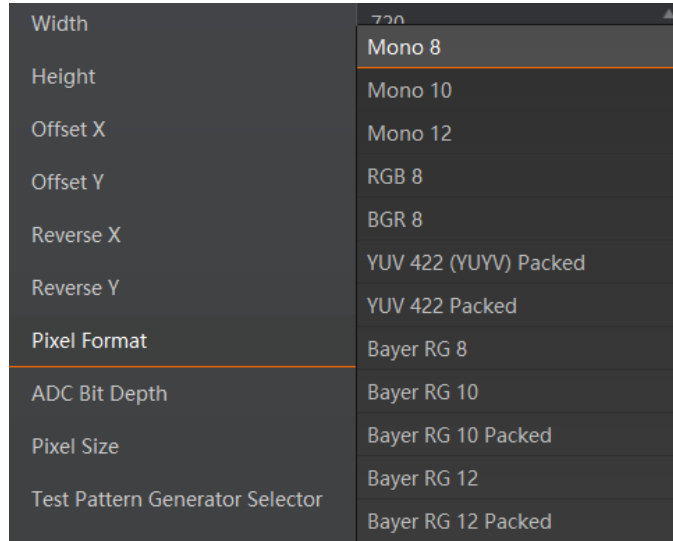

**Figure 12-5 Set Pixel Format**

With different ADC bit depths and pixel formats, the device's max. frame rate may differ. The larger the device's ADC bit depth value, the better the device's image quality, the lower the device's frame rate will be.

---

**Note**

The ADC bit depth function may differ by device models.

---

The default output data format of mono device is Mono 8. The default output data format of color device is Bayer 8, and it can be converted into RGB format via pixel interpolation algorithm. Bayer GR, Bayer GB, Bayer BG, Bayer RG and Bayer RBGG patterns are shown below.



**Figure 12-6 Bayer GR Pixel Pattern**

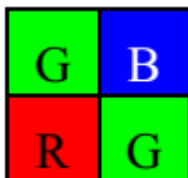

**Figure 12-7 Bayer GB Pixel Pattern**

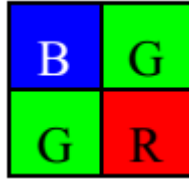

Figure 12-8 Bayer BG Pixel Pattern

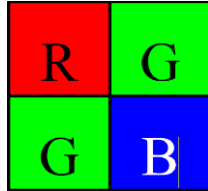

Figure 12-9 Bayer RG Pixel Pattern

## 12.5 Set Super Bayer

---

### Note

For different models of device, the super Bayer function may be different, please refer to the actual one you got.

---

In Bayer pixel format, the device supports Gamma function, LUT, contrast ratio, super palette control, and sharpness function after you enable **Super Bayer Enable**. Go to **Image Format Control** → **Super Bayer Enable**, and enable it according to actual demands.

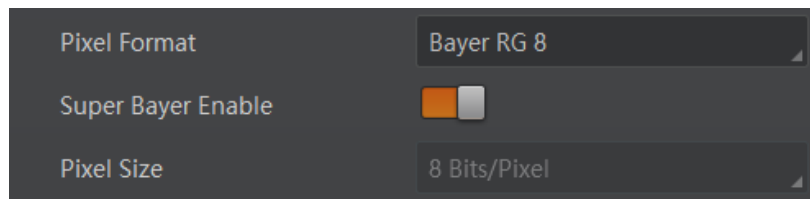

Figure 12-10 Set Super Bayer

## 12.6 Set Image Compression Mode

---

### Note

The function of the image compression is related with device models, firmware and pixel format, and the actual product you purchased should prevail.

---

Without affecting image quality, this function allows the device to compress data before transmitting to the external devices, and lower the usage of bandwidth.

## Steps

1. Go to **Image Format Control** → **Image Compression Mode**.
2. Select **HB** as **Image Compression Mode**.

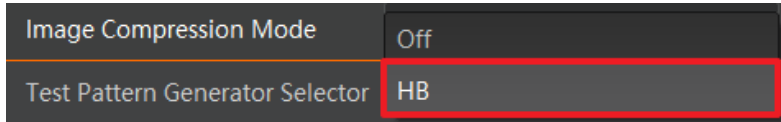

**Figure 12-11 Set Image Compression Mode**

3. Select **Compression** or **Burst** as **High Bandwidth Mode** according to actual demands.

---

## Note

**Compression** only compresses the image data, while **Burst** compresses the image data and increases the frame rate.

---

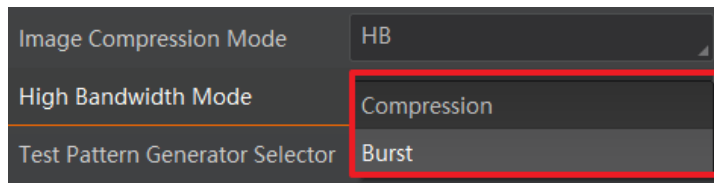

**Figure 12-12 Set High Bandwidth Mode**

4. (Optional) View the image compression mode's related parameters like **HB Abnormal Monitor** and **HB Version** in the **Device Control** attribute.

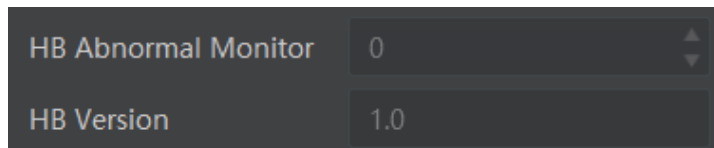

**Figure 12-13 HB Abnormal Monitor and Version**

- HB abnormal monitor is used to monitor image stream condition. If the size of compressed image is larger than that of raw image under HB function, this parameter will increase. When this parameter increases rapidly, it is recommended to disable the image compression mode.
- HB version refers to the version of this function.

## 12.7 Set Test Pattern

---

## Note

The test pattern may differ by device models.

---

The device supports test pattern function. When there is exception in real-time image, you can check whether image of test mode have similar problem to determine the reason. This function is disabled by default, and at this point, the outputted image by the device is real-time image. If this function is enabled, the outputted image by the device is test image.

Go to **Image Format Control** → **Test Pattern Generator Selector** → **Test Pattern**, and set **Test Pattern** according to actual demands.

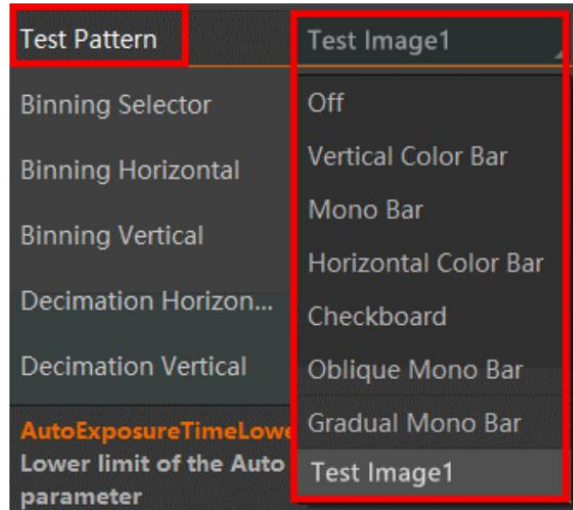

**Figure 12-14 Set Test Pattern**

The mono device offers 5 test patterns, including **Mono Bar**, **Checkboard**, **Oblique Mono Bar**, **Gradual Mono Bar**, and **Test Image 1**.

The color device offers 7 test patterns, including **Mono Bar**, **Checkboard**, **Oblique Mono Bar**, **Gradual Mono Bar**, **Vertical Color Bar**, **Horizontal Color Bar**, and **Test Image 1**.

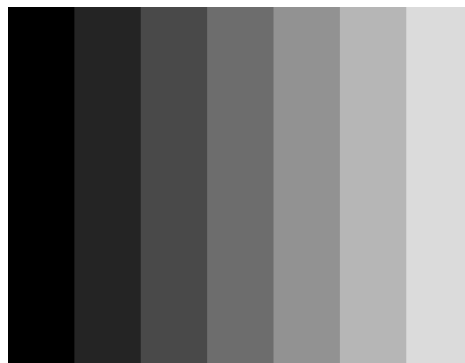

**Figure 12-15 Mono Bar Test Pattern**

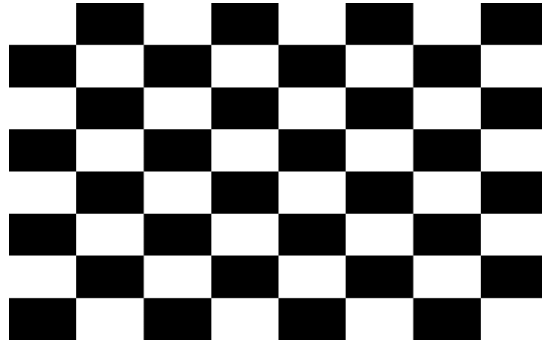

**Figure 12-16 Checkboard Test Pattern**

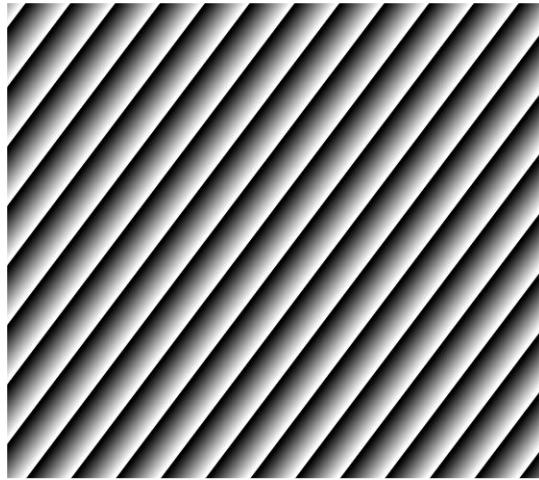

**Figure 12-17 Oblique Mono Bar Test Pattern**

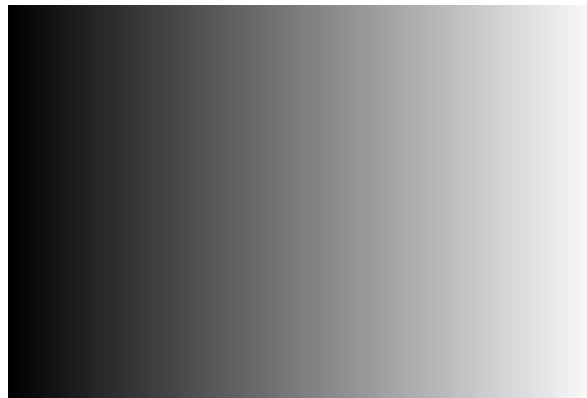

**Figure 12-18 Gradual Mono Bar Test Pattern**

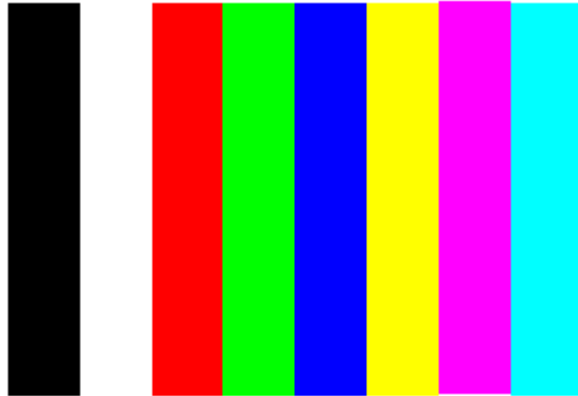

Figure 12-19 Vertical Color Bar Test Pattern



Figure 12-20 Horizontal Color Bar Test Pattern

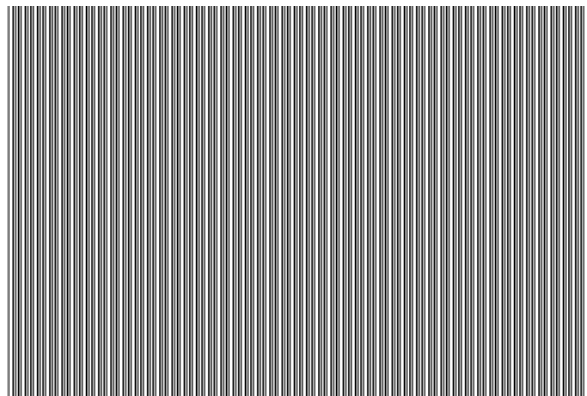

Figure 12-21 Test Image 1

---

**Note**

The pattern of the test image 1 may differ by device models.

---



## 12.8 Set Binning

**Note**

- **Binning Horizontal** is the image's width, and **Binning Vertical** is the image's height.
- The binning related functions may differ by device models.

The purpose of setting binning is to enhance sensibility. With binning, multiple sensor pixels are combined as a single pixel to reduce resolution and improve image brightness. Click **Binning Selector**, and set **Binning Horizontal** and **Binning Vertical** according to actual demands.

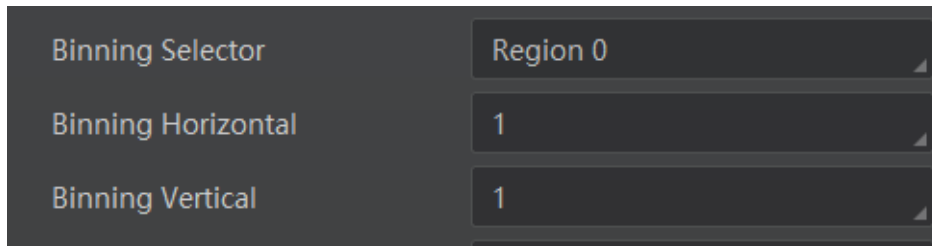

Figure 12-22 Set Binning

The device also supports binning mode function if the binning is  $2 \times 2$  and above. The binning mode defines how pixels are combined if the binning is  $2 \times 2$  and above. Click **Binning Mode**, and select **Sum** or **Average** according to actual demands.

- **Sum**: The values of the affected pixels are summed. This improves the signal-to-noise ratio, but also increases the device's response to light.
- **Average**: The values of the affected pixels are averaged. This greatly improves the signal-to-noise ratio without affecting the device's response to light.

Both binning modes (Sum and Average) reduce the amount of image data to be transferred.

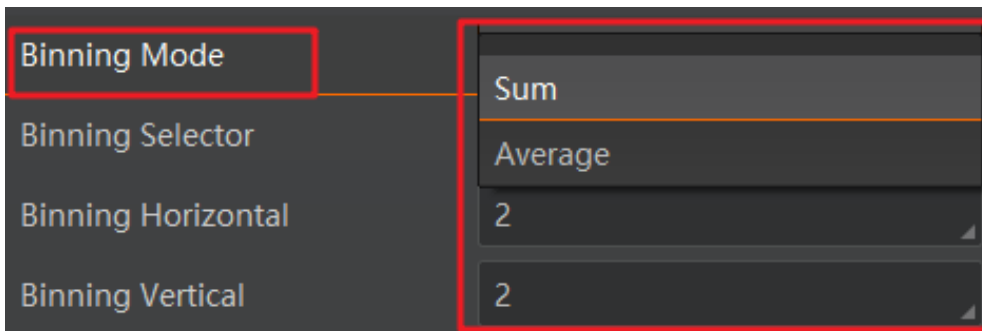

Figure 12-23 Set Binning Mode

**Note**

Configuring binning mode is supported when the device is acquiring images.

## 12.9 Set Decimation

---

 **Note**

- **Decimation Horizontal** is the image's width, and **Decimation Vertical** is the image's height.
  - The decimation related functions may differ by device models.
- 

The decimation feature allows you to reduce the number of sensor pixel columns or rows that are transmitted by the device. This procedure is also known as subsampling. It reduces the amount of data to be transferred and may increase the device's frame rate. Click **Image Format Control**, and set **Decimation Horizontal** and **Decimation Vertical** according to actual demands.

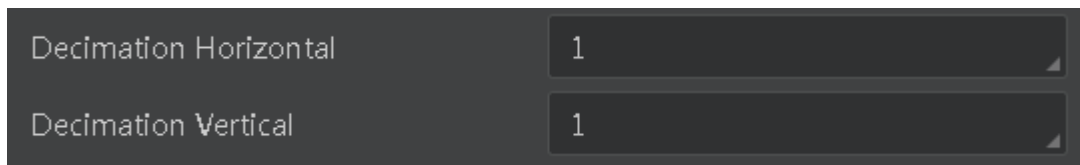

Figure 12-24 Set Decimation

## 12.10 Set Exposure Time Mode

---

 **Note**

- The exposure time mode may differ by device models.
  - If the device you got does not support **Ultrashort** exposure time mode, and then there is no **Exposure Time Mode** parameter, and your device supports **Standard** exposure time mode only by default.
- 

The device offers 2 types of exposure time modes, including **Ultrashort** mode and **Standard** mode. Go to **Acquisition Control** → **Exposure Time Mode**, and set **Exposure Time Mode** according to actual demands.

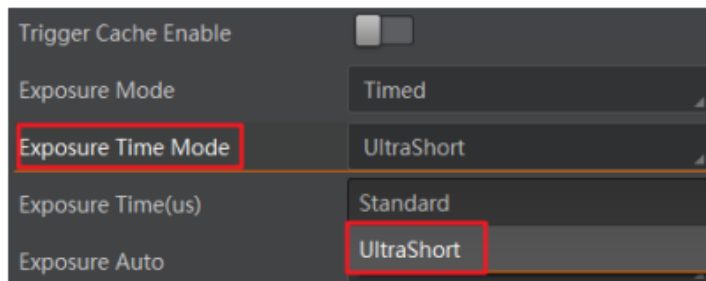

Figure 12-25 Set Exposure Time Mode

## 12.11 Set Exposure Auto

The device supports 3 types of exposure mode, including **Off**, **Once** and **Continuous**. Click **Acquisition Control** → **Exposure Auto**, and select **Exposure Auto** according to actual demands.

- **Off**: The device exposures according to the value set in **Exposure Time (μs)**.
- **Once**: The device adjusts the exposure time automatically according to the image brightness. After adjusting, it will switch to **Off** mode.
- **Continuous**: The device adjusts the exposure time continuously according to the image brightness.

When the exposure mode is set as **Once** or **Continuous**, the exposure time should be within the range of **Auto Exposure Time Lower Limit (μs)** and **Auto Exposure Time Upper Limit (μs)**.

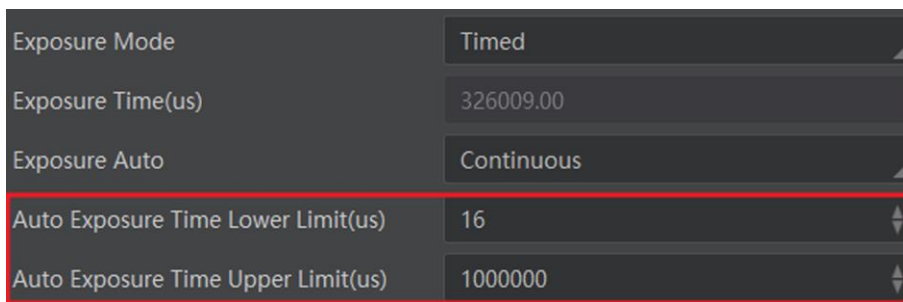

Figure 12-26 Set Exposure Time under Once or Continuous Mode

---

### Note

- If the device is under **Continuous** exposure mode, once external trigger mode is enabled, the device will automatically switch to **Off** exposure mode.
  - Some models of the device do not support **Once** or **Continuous** exposure mode. You can enter **Exposure Time (μs)** directly.
- 

## 12.12 Set WDR Mode

---

### Note

The WDR function may differ by device models.

---

The WDR function makes the device have a stable imaging ability in a changing environment between brightness and darkness.

### Steps

1. Go to **Acquisition Control** → **WDR Mode**.
2. Select **On** as **WDR Mode** to enable the function or **Off** to disable it.

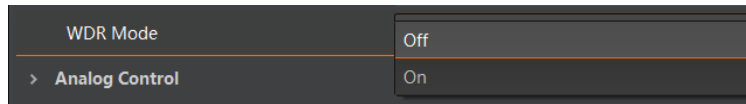

**Figure 12-27 Set WDR Mode**

3. Set **WDR Level** according to actual demands if the **WDR Mode** is **On**.

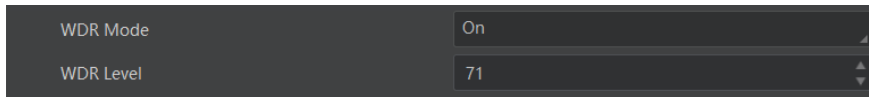

**Figure 12-28 Set WDR Level**

---

## **Note**

The range of WDR level is between 0 to 100. The larger the value, and the larger the wide dynamic range. It is recommended to set it as 71.

---

## **12.13 Set Sequencer Control and HDR**

The device supports sequencer or HDR functions, which allow you to configure multiple groups of parameters to acquire images.

---

## **Note**

- The device cannot support sequencer and HDR functions at the same time.
  - The sequencer or HDR function may differ by device models.
- 

### **12.13.1 Set Sequencer**

If the device supports sequencer, you can configure multiple groups of parameters including exposure time and gain.

#### **Steps**

1. Go to **Sequencer Control**, select **Off** as **Sequencer Mode**, and **On** as **Sequencer Configuration Mode**.

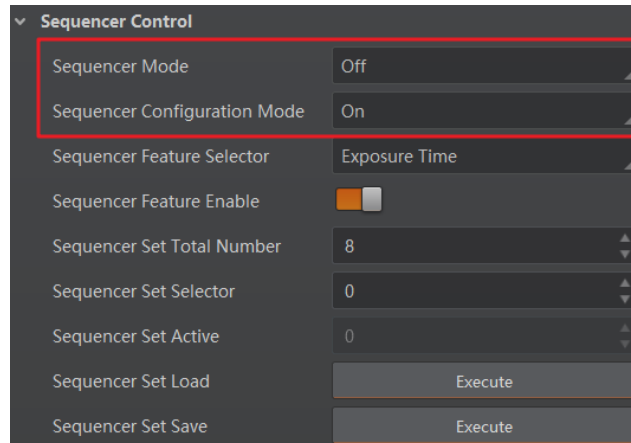

**Figure 12-29 Set Sequencer Control**

2. Set **Sequencer Set Total Number** to configure how many groups to join sequencer according to actual demands.
- 

**Note**

Up to 8 groups of parameters can be configured.

---

3. Set **Sequencer Set Selector** to select one group of parameters, and set **Sequencer Feature Selector** to configure specific parameters.

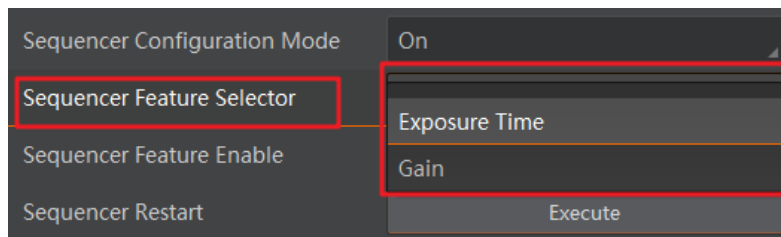

**Figure 12-30 Sequencer Feature Selector**

**Note**

- You should go to the corresponding parameters to set their detailed parameters.
  - **Sequencer Feature Enable** is enabled by default for configured parameters.
- 

4. (Optional) Click **Execute** in **Sequencer Set Load** to load selected parameters in **Sequencer Set Selector**.
  5. (Optional) Click **Execute** in **Sequencer Set Save** to save the selected group of parameters.
  6. Repeat step 3 to step 5 to configure other group of parameters.
  7. Select **On** as **Sequencer Mode** to start sequencer after configuration.
- 

**Note**

You cannot configure detailed parameters of group of parameters once sequencer is started.

---

8. (Optional) Click **Execute** in **Sequencer Restart** to let the sequencer start from the beginning group.

### 12.13.2 Set HDR

**Note**

- The HDR function may differ by device models.
- The device supports HDR (High Dynamic Range) function that the device acquires images based on customized settings, and each with its own exposure time and gain.

**Steps**

1. Go to **Acquisition Control** → **HDR Enable**, and enable **HDR Enable**.
2. Select **0, 1,2** or **3** as **HDR Selector** according to actual demands.
3. Set corresponding **HDR Shutter** and **HDR Gain**.

**Note**

Up to 4 HDR groups can be configured.

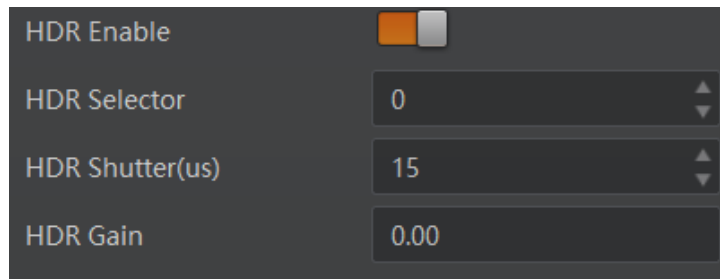

Figure 12-31 Set HDR

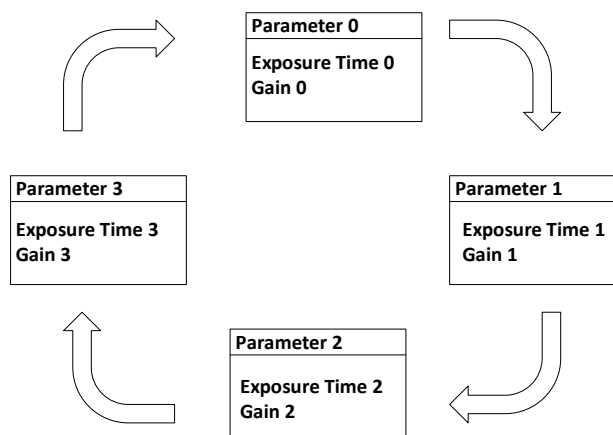

Figure 12-32 HDR Polling Demonstration

## 12.14 Set Gain

---

### Note

The gain function may differ by device models.

---

The device has 2 types of gain, including the analog gain and digital gain. The analog gain is applied before the signal from the device sensor is converted into digital values, while digital gain is applied after the conversion.

### 12.14.1 Set Analog Gain

The device supports 3 types of gain mode, including **Off**, **Once** and **Continuous**. Click **Analog Control** → **Gain Auto**, and select **Gain Auto** according to actual demands.

- **Off**: The device **adjusts** gain according to the value configured by user in **Gain**.
- **Once**: The device adjusts the gain automatically according to the image brightness. After adjusting, it will switch to **Off** mode.
- **Continuous**: The device **adjusts** the gain continuously according to the image brightness.

When the gain mode is set as **Once** or **Continuous**, the gain should be within the range of **Auto Gain Lower Limit (dB)** and **Auto Gain Upper Limit (dB)**.

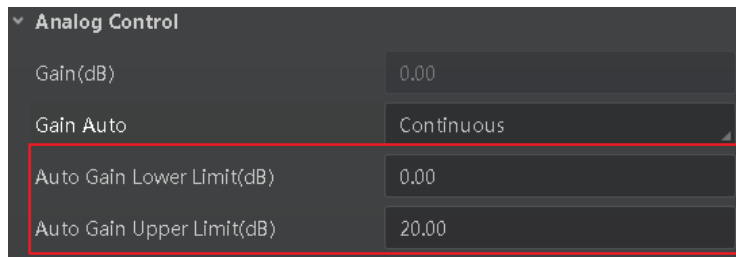

Figure 12-33 Set Gain under Once or Continuous Mode

---

### Note

- When increasing gain, the image noise will increase too, which will influence image quality. If you want to increase image brightness, it is recommended to increase the device's exposure time first. If the exposure time reaches its upper limit, and at this point, you can increase gain.
  - Some models of the device do not support **Once** or **Continuous** gain mode. You can enter **Gain (dB)** directly.
-

## 12.14.2 Set Digital Gain

Apart from analog gain, the device supports digital gain function. When analog gain reaching its upper limit and the image is still too dark, it is recommended to improve image brightness via digital gain.

Click **Analog Control**, enable **Digital Shift Enable**, and enter **Digital Shift** according to actual demands.

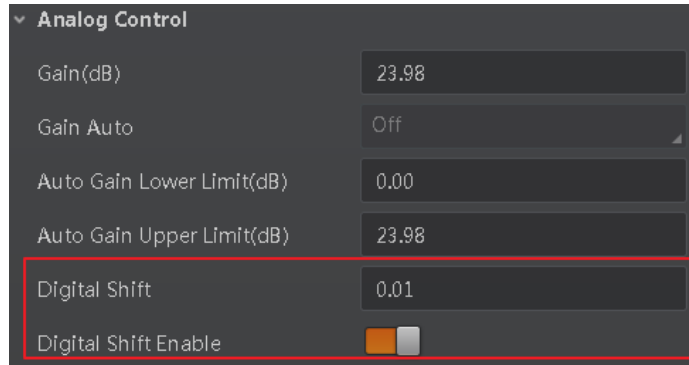

Figure 12-34 Set Digital Gain

---

### Note

When increasing the digital gain, the image noise will greatly increase too, which will severely influence image quality. It is recommended to use analog gain first, and then to adjust digital gain if the analog gain cannot meet demands.

---

## 12.15 Set Sensor Mode

---

### Note

The sensor mode function may differ by device models.

---

The device provides two types of sensor mode, including high full well capacity and high sensitivity.

- High Full Well Mode: It greatly improves the overall brightness of images and is applicable to low-light environment.
- High Sensitivity: It improves the image's sensitivity.



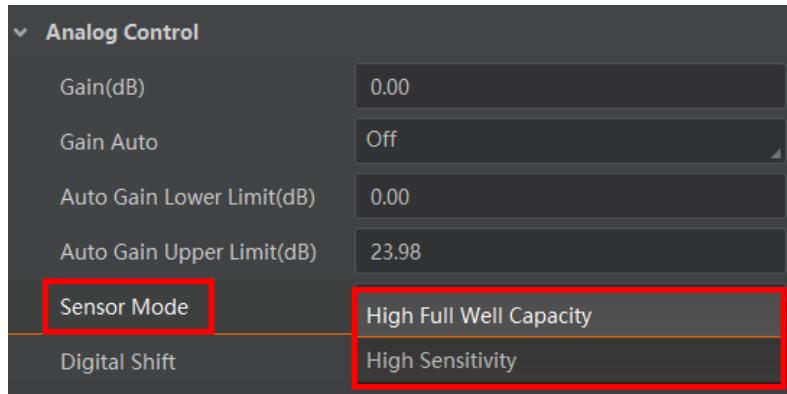

Figure 12-35 Set Sensor Mode

## 12.16 Set Brightness

The device brightness refers to the brightness when the device adjusts image under **Once** or **Continuous** exposure mode, or **Once** or **Continuous** gain mode.

### Note

- You should enable **Once** or **Continuous** exposure mode, or **Once** or **Continuous** gain mode first before setting brightness.
- After setting brightness, the device will automatically adjust exposure time to let image brightness reach target one. Under **Once** or **Continuous** exposure mode, or **Once** or **Continuous** gain, the higher the brightness value, the brighter the image will be.

Go to **Analog Control** → **Brightness**, and enter **Brightness** according to actual demand.

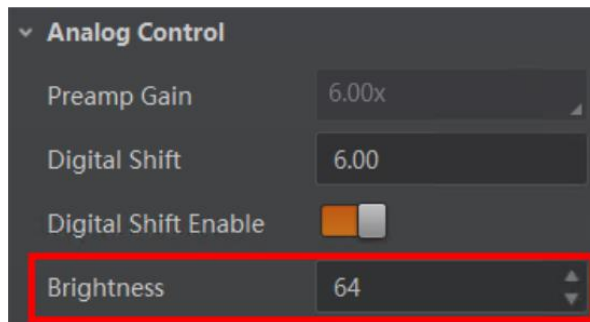

Figure 12-36 Set Brightness

## 12.17 Set Black Level

---

### Note

The black level may differ by device models.

---

The device supports black level function that allows you to change the overall brightness of an image by changing the gray values of the pixels by a specified amount.

Go to **Analog Control** → **Black Level Enable**, enable **Black Level Enable**, and enter **Black Level** according to actual demands.

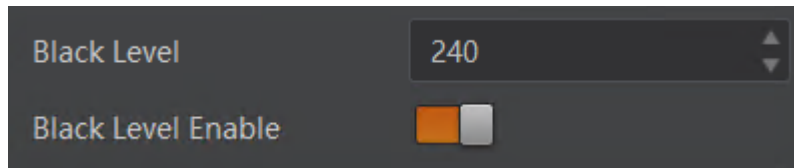

Figure 12-37 Set Black Level

## 12.18 Set White Balance

---

### Note

White balance is only available for color devices.

---

The white balance refers to the device color adjustment depending on different light sources. Adjust the R/G/B ratio to ensure that the white regions are white under different color temperatures. Ideally, the proportion of R/G/B in the white region is 1:1:1.

The device supports 3 types of white balance mode, including **Off**, **Once** and **Continuous**. Click **Analog Control** → **White Balance Auto**, and select **White Balance Auto** according to actual demands.

- **Off**: You need to set the R, G, B ratio manually via **Balance Ratio Selector** and **Balance Ratio**. The range is from 1 to 16376, and 1024 means ratio is 1.0.
- **Once**: Adjust the white balance for a certain amount of time then stop.
- **Continuous**: Adjust the white balance continuously.

It is recommended to correct white balance when there is great difference between the device's color effect and actual effect. You can correct white balance as shown below.

### Steps

1. Put a white paper in the range of the device's field of view, and make sure the paper covers the entire field of view.
2. Set exposure and gain. It is recommended to set image brightness value between 120 and 160..
3. Select **Once** as **Balance White Auto**, and the device will automatically adjust white balance for once.

If there is still great difference between correction effect and actual color, it is recommended to correct white balance according to following steps.

### Steps

---

#### Note

- Here we take **Green** as an example. For specific **Balance Ratio Selector** value, please refer to the actual condition.
  - In order to avoid repeated correction after rebooting the device, it is recommended to save white balance parameter to **User Set** after white balance correction. You can refer to the Section **Save and Load User Set** for details.
  - If the light source and color temperature in environment change, you need to correct white balance again.
- 

1. Select **Off** as **Balance White Auto**. At this time, **Balance Ratio** is 1024.
2. Find corresponding R/G/B channel in **Balance Ratio Selector**. Here we take **Green** as an example.
3. Find device's R/G/B value.
4. Take **Green** as correction standard, and manually adjust other two channels (R channel and B channel) to let these three channels have same value.

## 12.19 Set Gamma Correction

---

#### Note

- The Gamma correction function may differ by device models.
  - Regarding the color device in Bayer pixel format, you need to enable **Super Bayer Enable** first before using Gamma correction function.
- 

The device supports Gamma correction function. Generally, the output of the device's sensor is linear with the photons that are illuminated on the photosensitive surface of the sensor. Gamma correction provides a non-linear mapping mechanism as shown below.

- Gamma value between 0.5 and 1: image brightness increases, dark area becomes brighter.
- Gamma value between 1 and 4: image brightness decreases, dark area becomes darker.

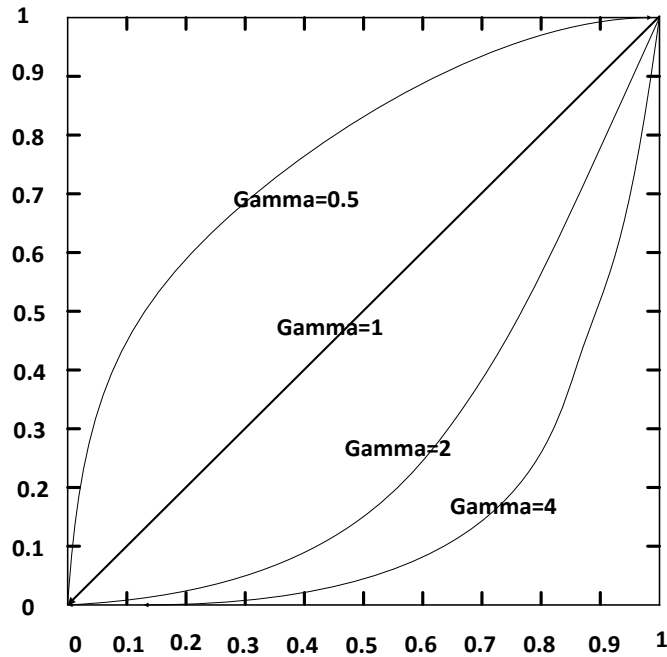

Figure 12-38 Set Gamma Correction

There are 2 types of Gamma correction, including **User** mode and **sRGB** mode.

## User Mode

### Steps

1. Go to **Analog Control** → **Gamma Selector**.
2. Select **User** as **Gamma Selector**.
3. Enable **Gamma Enable** to enable it.
4. Enter **Gamma** according to actual demands, and its range is from 0 to 4.

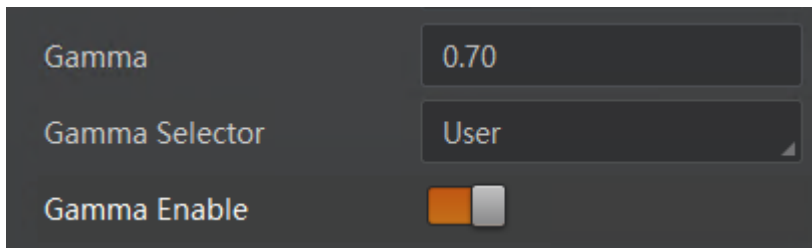

Figure 12-39 Set User Mode

## sRGB Mode

### Steps

1. Go to **Analog Control** → **Gamma Selector**.
2. Select **sRGB** as **Gamma Selector**.

3. Enable **Gamma Enable** to enable it.

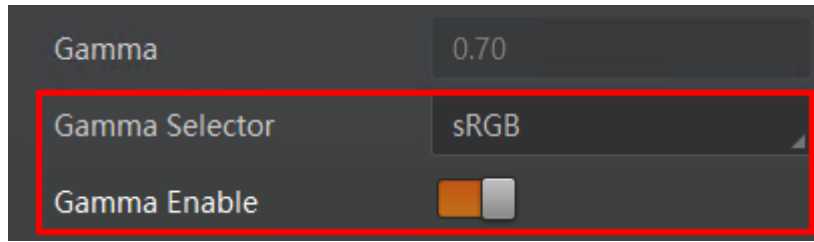

Figure 12-40 Set sRGB Mode

## 12.20 Set Sharpness

### Note

- The sharpness function may differ by device models.
- Regarding the color device in Bayer pixel format, you need to enable **Super Bayer Enable** first before using sharpness function.

The device supports sharpness function that can adjust the sharpness level of the image edge, You can set sharpness as shown below.

Go to **Analog Control** → **Sharpness Enable**, enable **Sharpness Enable**, and enter **Sharpness** according to actual demands.

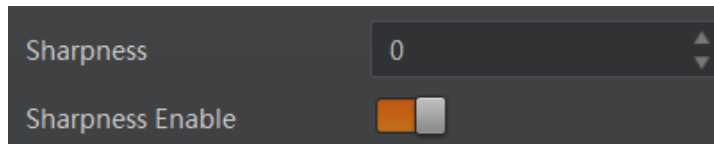

Figure 12-41 Set Sharpness

## 12.21 Set Digital Noise Reduction

### Note

- The digital noise reduction function may differ by device models.
- Excessive noise reduction will affect the image details.

The function of digital noise reduction can increase the image's SNR and improve its quality.

### Steps

1. Go to **Analog Control** → **Digital Noise Reduction Mode**.
2. Select **Expert** as **Digital Noise Reduction Mode**.
3. Enter **Denoise Strength** and **Noise Correct** according to actual demands.

- **Denoise Strength** refers to the intensity of the digital noise reduction, you can increase it to have a better effect.
- **Noise Correct** refers to the noise horizontal correction value, and it is used to adjust the noise curve.

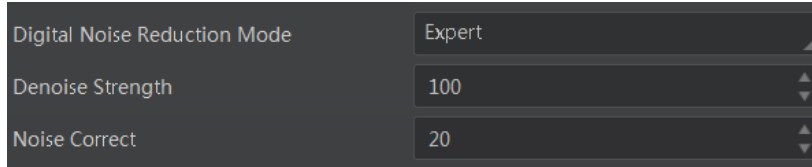

Figure 12-42 Set Digital Noise Reduction

## 12.22 Set Channel Correct Mode

---

**Note**

The channel correct mode function may differ by device models.

---

The channel correction function allows you to adjust the image's uniformity, and you can set channel correct mode as shown below.

Go to **Analog Control** → **Channel Correct Mode**, and select **Channel Correct Mode** according to actual demands.

- **Active Mode** adjusts channel difference in accordance with actual images in real time.
- **Noise Correct** adjusts channel difference in accordance with configured parameters in real time.

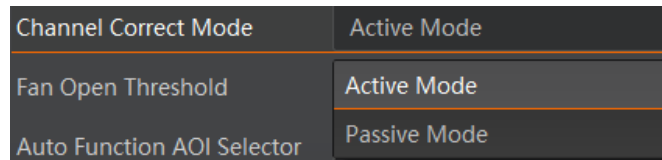

Figure 12-43 Set Channel Correct Mode

## 12.23 Set Contrast Ratio

---

**Note**

- The contrast ratio function may differ by device models.
  - Make sure that the live view is enabled, and Gamma correction and LUT function is disabled before using the contrast ratio function.
  - Regarding the color device in Bayer pixel format, you need to enable **Super Bayer Enable** first before using contrast ratio function.
  - The range of **Contrast Ratio** is from 0 to 100.
-

The device supports the contrast ratio function that adjusts the intensity of light and darkness and color. The larger the contrast ratio, and more clear the image is. Go to **Analog Control**, enable **Contrast Ratio Enable**, and set **Contrast Ratio** according to actual demands.

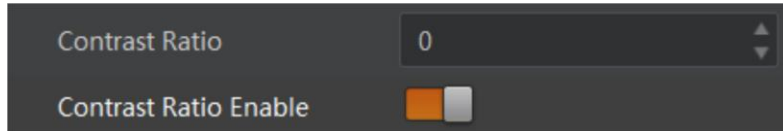

Figure 12-44 Set Contrast Ratio

## 12.24 Set AOI

---

### Note

- The AOI function may differ by device models.
  - AOI 1 is used when the device is in once or continuous exposure mode, and AOI 2 is used when the device is in once or continuous white balance mode.
- 

The device supports AOI function that can adjust the brightness and white balance of the entire image based on the area you selected.

### Steps

1. Click **Analog Control** → **Auto Function AOI Selector**, and select **AOI 1** or **AOI 2 Auto Function AOI Selector**.
2. Enter **Auto Function AOI Width**, **Auto Function AOI Height**, **Auto Function AOI Offset X**, and **Auto Function AOI Offset Y** according to actual demands.
3. Enable **Auto Function AOI Usage Intensity** if **AOI 1** is selected as **Auto Function AOI Selector**. Or enable **Auto Function AOI Usage White Balance** if **AOI 2** is selected as **Auto Function AOI Selector**.

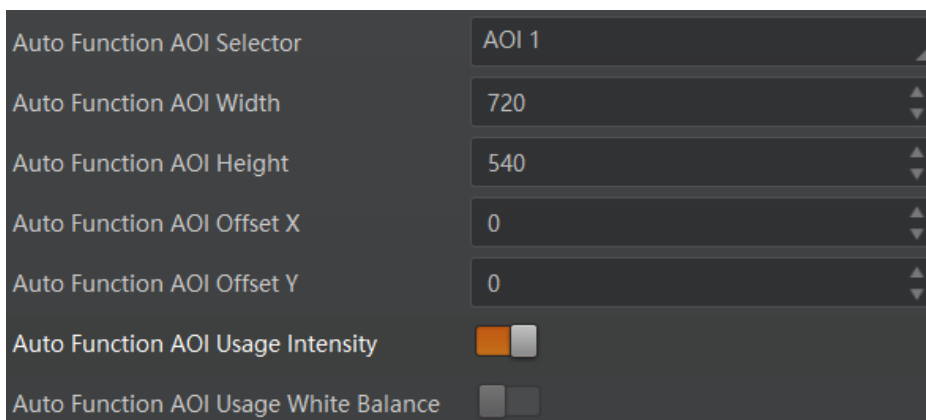

Figure 12-45 Set AOI

## 12.25 Set Color Transformation Control

### Note

- The function of color transformation control is only available for color devices.
- Currently, **RGB to RGB** is available for **Color Transformation Selector** only.

After the image is processed by the white balance, the overall image will be dark, and at the same time, various colors may deviate from their standard values to varying degrees. At this time, it is necessary to multiply the color of the image by the correction matrix to correct each color to its standard value, so that the overall color of the image is more vivid. The color correction function is implemented by multiplying each RGB component by a correction matrix. The currently supported color conversion module is RGB to RGB. Two methods are available to set color transformation control.

- Method 1:

### Steps

1. Go to **Color Transformation Control**, and enable **CCM Enable**.
2. Select **Color Transformation Value Selector**, and set **Color Transformation Value** according to actual demand.

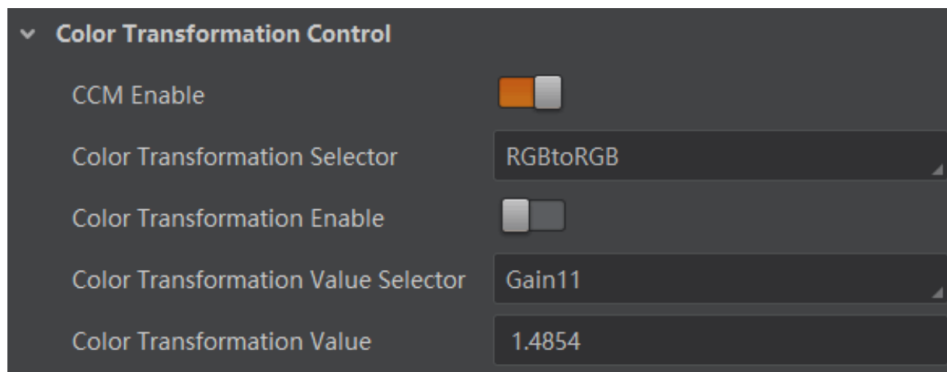

Figure 12-46 Method 1

### Note

- **CCM Enable** is used to enable color correction function. If the device you purchased does not have **CCM Enable**, then the color correction function is enabled by default.
  - Color correction is achieved by adjusting the values of the parameters in **Color Transformation Value Selector**, where Gain00, Gain10, and Gain20 adjust the R component of the red pixel, Gain01, Gain11, and Gain21 adjust the G component of the green pixel, and Gain02, Gain12, and Gain22 adjust the B component of the blue pixel.
- Method 2: Go to **Color Transformation Control**, enable **Color Transformation Enable**, set **Hue** and **Saturation** to adjust **Color Transformation Value**.



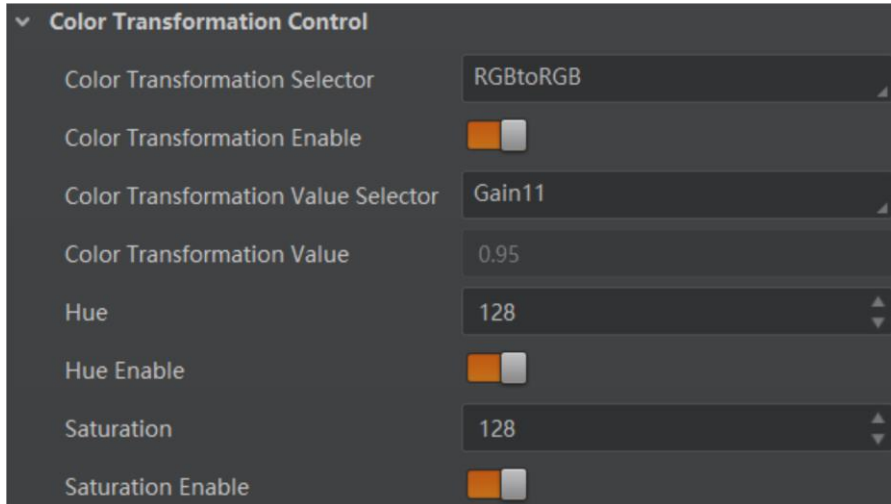

Figure 12-47 Method 2

## 12.26 Set Hue

---

### Note

- The hue function is only available for color devices.
- In Mono pixel format, hue function is not supported.
- The range of hue is between 0 and 255.

---

Adjusting the hue shifts the colors of the image. After hue is set, the device will perform color correction based on the hue value to bring the image tone to the target value. For example, when hue is set to 128, the red in the image appears as real red. When hue is 0, the hue is reversed 128 degrees counterclockwise, and red becomes blue. When hue is 255, the hue rotates 128 degrees clockwise, and red becomes green.

### Steps

1. Go to **Color Transformation Control**.
2. Enable **Color Transformation Enable**, and enable **Hue Enable**.
3. Enter **Hue** according to actual demands.

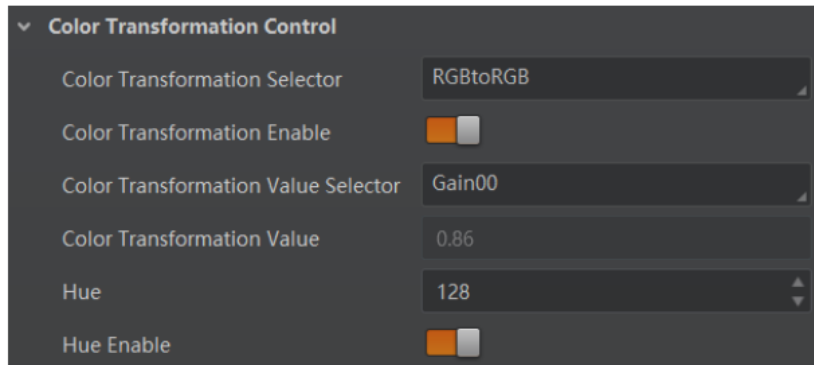

Figure 12-48 Set Hue

## 12.27 Set Saturation

### Note

- The saturation function is only available for color devices.
- In Mono pixel format, hue function is not supported.
- The range of saturation is between 0 and 255.

Adjusting the saturation changes the colorfulness of the colors. A higher saturation, for example, makes colors easier to distinguish.

### Steps

1. Go to **Color Transformation Control**.
2. Enable **Color Transformation Enable**, and enable **Saturation Enable**.
3. Enter **Saturation** according to actual demands.

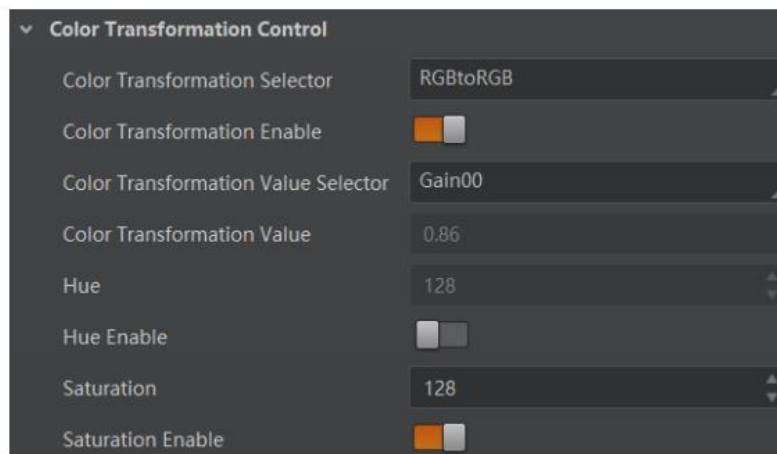

Figure 12-49 Set Saturation

## 12.28 Set Super Palette Control

### Note

- The function of super palette control may differ by device models.
- Regarding the color device in Bayer pixel format, you need to enable **Super Bayer Enable** first before using super palette control function.

The super palette control function allows you to select different color areas in the image to set customized hue and saturation values.

### Steps

1. Go to **Super Palette Control**, and enable **Super Palette Enable**.
2. Select **Super Palette Selector**.

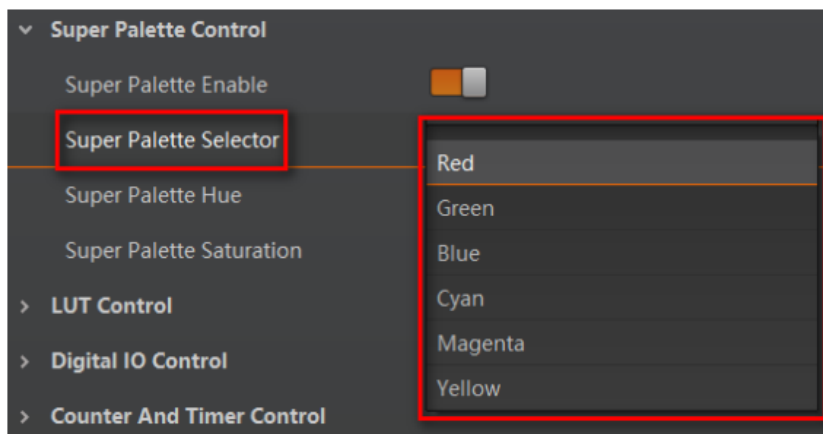

Figure 12-50 Super Palette Selector

3. Set corresponding **Super Palette Hue** and **Super Palette Saturation** according to actual demands.

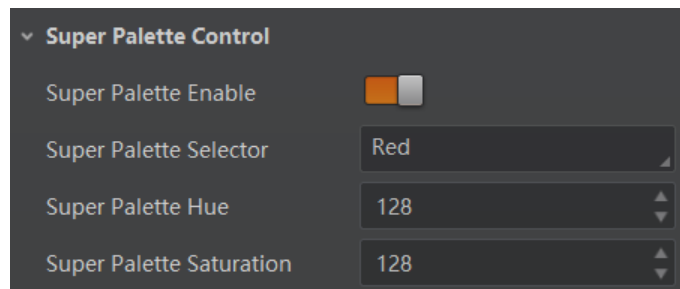

Figure 12-51 Set Super Palette Control

## 12.29 Set LUT

A Look-Up Table (LUT) is a customizable grayscale-mapping table. You can stretch, amplify the grayscale range that interests you. The mapping can be linear or customized curve.

---

### Note

- You cannot use Gamma correction function and LUT function at the same time.
  - The parameter of **LUT Save** may differ by device models. If the device has no **LUT Save**, the settings you configured will be saved in the device in real time.
  - For different models of device, the **LUT Index** and **LUT Value** range may differ, please refer to the actual one you got.
  - Regarding the color device in Bayer pixel format, you need to enable **Super Bayer Enable** first before using LUT function.
- 

### Steps:

1. Click **LUT Control**, and enable **LUT Enable**.
2. Enter **LUT Index** and **LUT Value** according to actual demands.
3. Click **Execute** in **LUT Save** to save it.

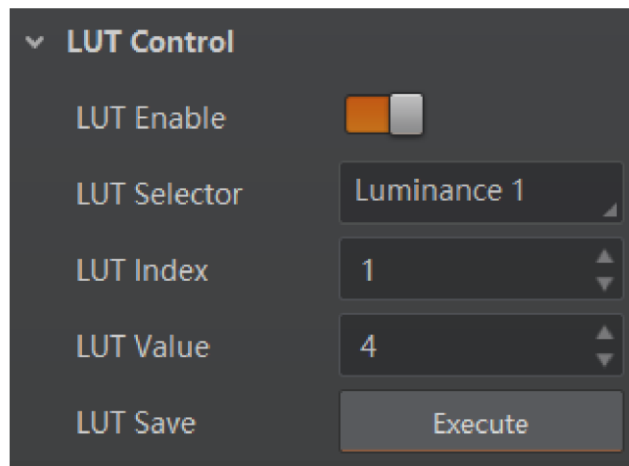

Figure 12-52 Set LUT

## 12.30 Set Shading Correction

### Note

The specific shading correction types that devices support and configuration methods may differ by device models.

---

The device supports shading correction function that improves the image uniformity when you acquire a non-uniformity image due to external conditions. The supported shading correction type includes LSC correction, FPNC correction, and PRNUC correction.

### 12.30.1 LSC Correction

LSC correction stands for Lens Shading Correction that eliminates non-uniform illumination brought by lens. The images before LSC correction and after correction are shown below.

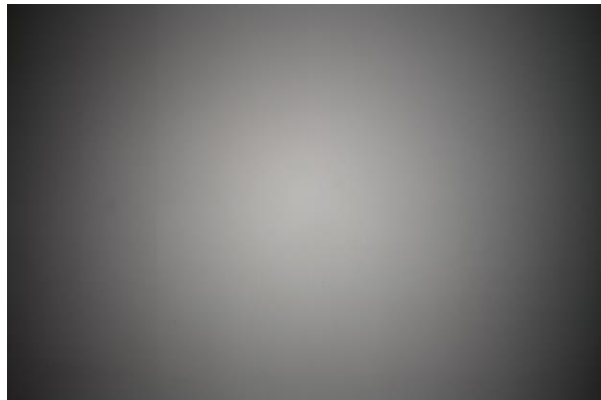

**Figure 12-53 Before LSC Correction**

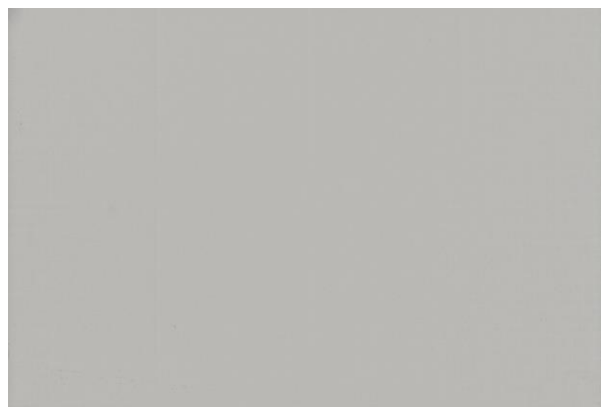

**Figure 12-54 After LSC Correction**

**Steps:**

1. Go to **Shading Correction**, and select **LSC Correction** as **Shading Selector**.
2. Click **Execute** in **Activate Shading** to let the client software automatically calculate.
3. Enable **LSC Enable**.

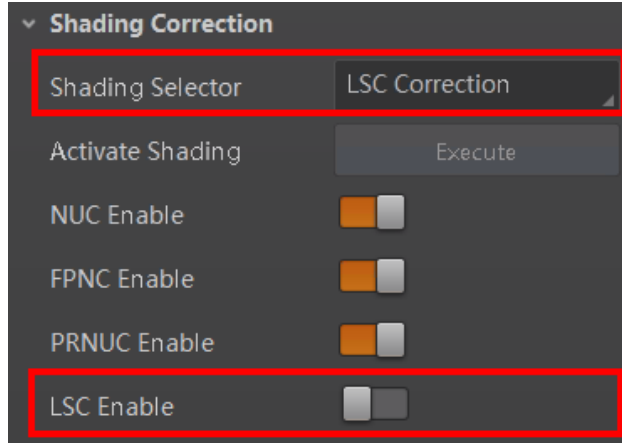

**Figure 12-55 LSC Correction**

---

**Note**

- LSC correction should be executed in full resolution. If you are only interested in a certain region of the image, you can set a Region of Interest (ROI) instead.
  - Specific steps for executing LSC correction may differ by device models
- 

### 12.30.2 Other Corrections

Other corrections include FPNC correction and PRNUC correction. The images before correction and after correction are shown below.

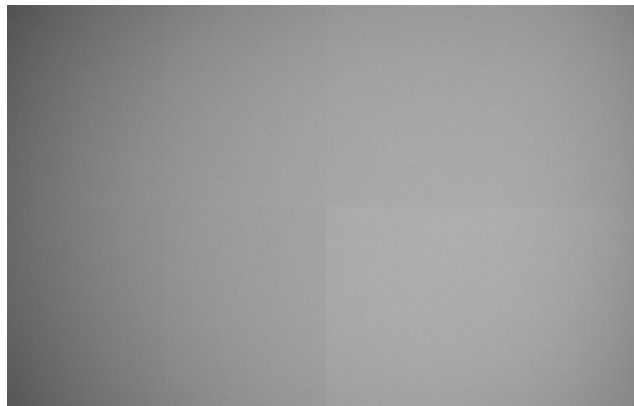
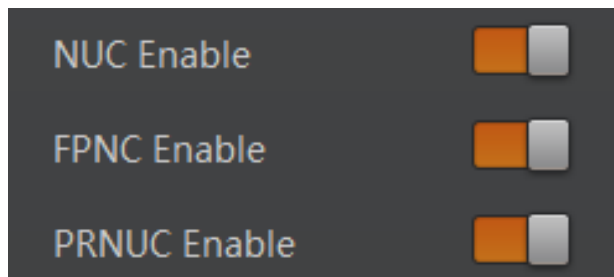

**Figure 12-56 Before Correction**



**Figure 12-57 After Correction**

Go to **Shading Correction**, and enable **NUC Enable**. The **FPNC Enable** and **PRNUC Enable** will be automatically enabled or disabled according to the device's condition.



**Figure 12-58 Other Corrections**

## Chapter 13 Other Functions

### 13.1 Device Control

#### Note

The specific device control parameters may differ by device models.

In **Device Control**, you can view device information, edit device name, reset device, etc. The specific parameters in **Device Control** are shown below.

**Table 13-1 Parameter Description**

Parameter	Read/Write	Description
Device Type	Read Only	It is the device type.
Device Scan Type	Read Only	It is the scan type of the device's sensor.
Device Vendor Name	Read Only	It is the name of the manufacturer of the device.
Device Model Name	Read Only	It is the model of the device.
Device Manufacturer Info.	Read Only	It is the manufacturer information about the device.
Device Version	Read Only	It is the version of the device.
Device Firmware Version	Read Only	It is the firmware version of the device.
System of Chip Version	Read Only	It is the chip system version of the device.
Device Serial Number	Read Only	It is device's serial number.
Device ID	Read Only	It is the device's ID.
Device User ID	Read & Write	Device name and it is empty by default. You can set according to your preference. <ul style="list-style-type: none"> <li>• If User ID is empty, the client software displays the device model.</li> <li>• If you set it, the client software displays the User ID you set.</li> </ul>
Device Uptime (s)	Read Only	It is the period of time when device is powered up.
Board Device Type	Read Only	It is the device type.
Device Connection Selector	Read & Write	It selects which connection of the device to control.



## GigE Area Scan Camera User Manual

---

Parameter	Read/Write	Description
Device Connection Speed (Mbps)	Read Only	It indicates the speed of transmission of the specified connection.
Device Link Selector	Read & Write	It selects which link of the device to control
Device Link Speed (Mbps)	Read Only	It indicates the speed of transmission negotiated on the specified link.
Device Link Connection Count	Read Only	It returns the number of physical connection of the device used by a particular link.
Device Link Heartbeat Mode	Read & Write	It activates or deactivates the link's heartbeat.
Device Stream Channel Count	Read only	It indicates the number of streaming channels supported by the device.
Device Stream Channel Selector	Read & Write	It selects the stream channel to control.
Device Stream Channel Type	Read Only	It reports the type of the stream channel.
Device Stream Channel Link	Read Only	It is the index of device's link to use for streaming the specified stream channel.
Device Stream Channel Endianness	Read Only	It is the endianness of multi-byte pixel data for this stream.
Device Stream Channel Packet Size (B)	Read & Write	It specifies the stream packet size, in bytes, to send on the selected channel for a transmitter or specifies the maximum packet size supported by a receiver.
Device Event Channel Count	Read Only	It indicates the number of event channels supported by the device.
Device Character Set	Read Only	It is character set used by the strings of the device's bootstrap registers.
Device Reset	Write Only	Click <b>Execute</b> to reset the device.
Device Temperature Selector	Read & Write	It selects device component to view its temperature. Currently, only sensor can be selected only.
Device Temperature	Read Only	It displays the temperature of selected components in <b>Device Temperature Selector</b> .
Relative Humidity	Read Only	It displays the device's internal relative humidity.
Device Fan Enable	Read & Write	It enables fan function.

Parameter	Read/Write	Description
TEC Enable	Read & Write	It enables TEC function.
TEC Temperature	Read & Write	It sets the target of TEC temperature in degrees Celsius (°C).
TEC Voltage	Read Only	It is the TEC voltage.
Find Me	Read & Write	The function of finding me is executed. Click <b>Execute</b> to find the currently operating device.
Device Max Throughput (Kbps)	Read Only	It is max. bandwidth of the data that can be streamed out of the device.
Device PJ Number	Read Only	It is the device's project number.
HB Abnormal Monitor	Read Only	It monitors image stream condition.
HB Version	Read Only	It is the version of the image compression mode.

## 13.2 Embed Information into Image

The device supports embedding information into image data. The information will be embedded into the image according to the enabling condition of each type of information in the order of the image embedding information listed in the table below.

---

### Note

- **White Balance** is only available for the color devices.
  - **Width, Height, Offset X, Offset Y** and **Pixel Format** are image embedding information that the device supporting Chunk function has.
- 

**Table 13-2 Image Embedding Information**

Image Embedding Info.	Byte	Data Format
Timestamp	4	Refer to figure 11-1
Gain	4	4 bytes are used to transfer the gain information. Each low 8 bits of the 4 valid data are combined to transfer the gain information. Value Range: 0 to 1023. Note: High bits will be complemented with 0 automatically.
Exposure	4	4 bytes are combined to show the exposure time, and the unit is $\mu\text{s}$ .
Brightness Info	4	Ranges from 0 to 4095
White Balance	8	R/G/B occupies 2 bytes each. Value Range: 0 to 4095.
Frame Counter	4	Ranges from 0 to $2^{32}-1$
Ext Trigger Count	4	Ranges from 0 to $2^{32}-1$

Image Embedding Info.	Byte	Data Format
Line Input Output	4	The 1 <sup>st</sup> byte is input, and each bit corresponds to 1 input. The 2 <sup>nd</sup> byte is output, 3 <sup>rd</sup> and 4 <sup>th</sup> bytes are reserved.
Width	4	Ranges from 0 to $2^{32}-1$
Height	4	Ranges from 0 to $2^{32}-1$
Offset X	4	Ranges from 0 to $2^{32}-1$
Offset Y	4	Ranges from 0 to $2^{32}-1$
Pixel Format	4	Ranges from 0 to $2^{32}-1$
ROI Position	8	The starting coordinates occupy two bytes each with the column coordinates at the front and the row coordinates at the back. The length and width coordinates each occupy two bytes.

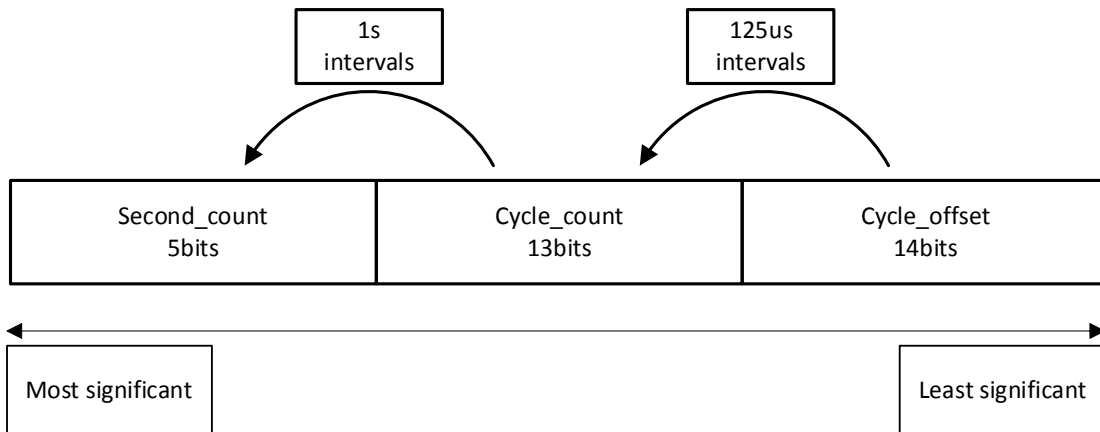

**Figure 13-1 Data Format of Timestamp**

There are two ways to embed information into the image, including watermark function and Chunk function.

**Note**

- Watermark function is not available if the device enables image compression mode.
- The Chunk function may differ by device models.
- The device uses Chunk function in priority if it supports both watermark and Chunk function.

## Watermark Settings

### Steps

1. Go to **Image Format Control** → **Embedded Image Info Selector**, and select **Embedded Image Info Selector** according to actual demands.

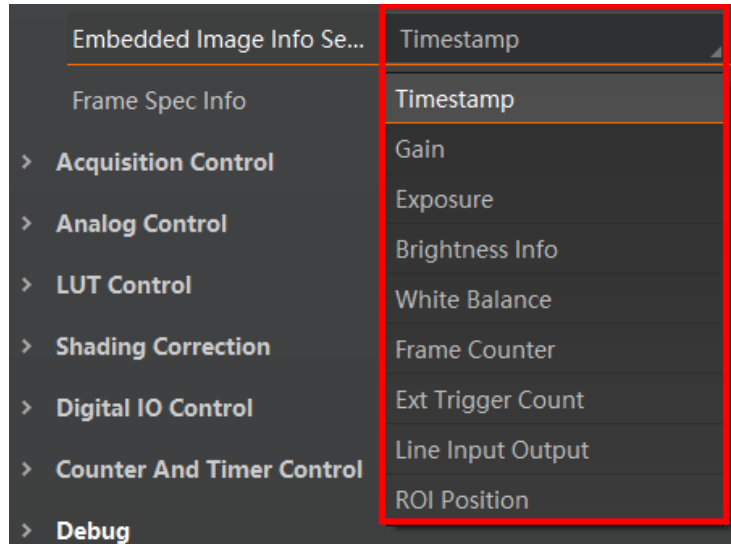

**Figure 13-2 Select Embedded Image Info Selector**

2. Enable **Frame Spec Info** to add watermark into images.

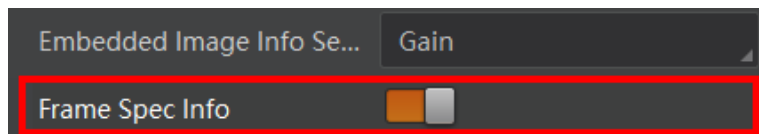

**Figure 13-3 Enable Frame Spec Info**

3. (Optional) Repeat steps above to add multiple watermarks.
4. Click  on the control toolbar of the client software to view specific watermark information.

---

### Note

The watermark is embedded into the starting position of the first line of image data. If the ROI is small and the first line of image data is insufficient to embed information, the information will be embedded into the second line of image data.

---

## Chunk Settings

### Steps

1. Go to **Chunk Data Control** → **Chunk Mode Active**, and **Chunk Mode Active**.

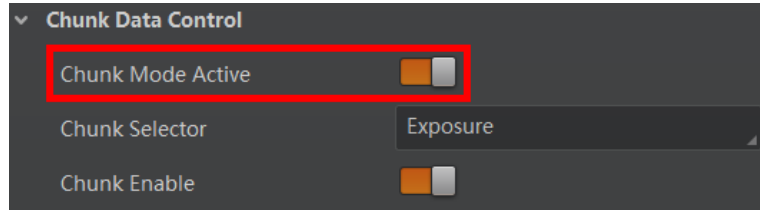

**Figure 13-4 Enable Chunk Mode Active**

2. Select **Chunk Selector** according to actual demands.

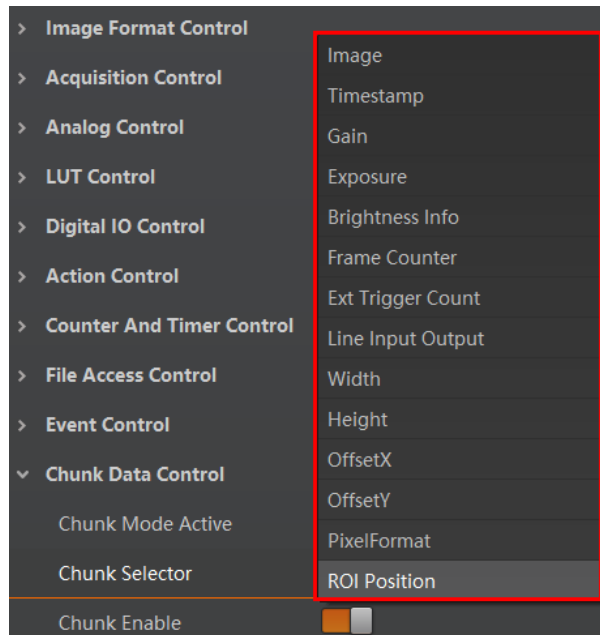

**Figure 13-5 Select Chunk Selector**

3. Enable **Chunk Enable** to embed information into the image.

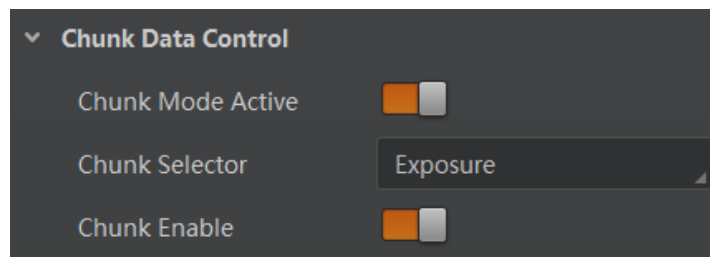

**Figure 13-6 Chunk Enable**

4. (Optional) Repeat steps above to add multiple Chunk information types.

5. Click  on the control toolbar of the client software to view specific information.

## 13.3 Set Action Command

**Note**

- The action command function may differ by device models.
- Only V3.1.0 and above version of MVS client software support GigE Vision action command.

The action command allows you to execute actions on multiple devices at roughly the same time by using a single broadcast protocol message.

**Steps**

1. Go to **Transport Layer Control** → **GEV IEEE 1588**, and enable **GEV IEEE 1588**.
2. Go to **Acquisition Control** → **Trigger Selector**, and select **Frame Burst Start**.
3. Select **On** as **Trigger Mode**.
4. Select **Action 1** as **Trigger Source**.
5. Go to **Tool** → **GigE Vision Action Command** in the menu bar.

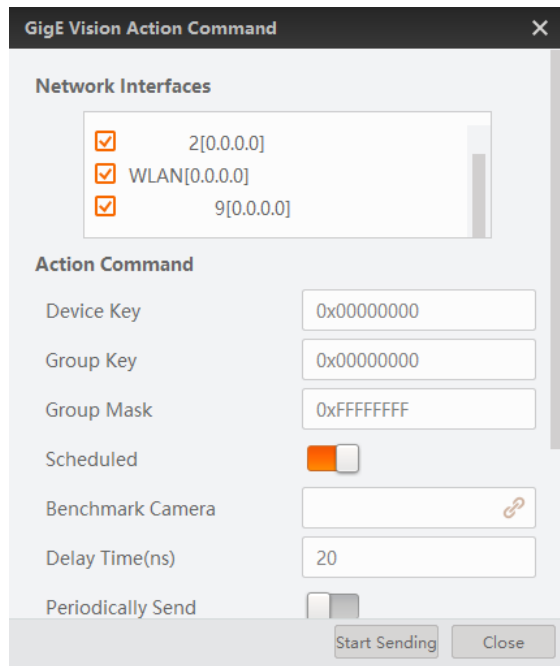

**Figure 13-7 GigE Vision Action Command**

6. Select **Network Interfaces** to set the subnet that the command to be sent to.
7. Enter **Device Key**, **Group Key**, and **Group Mask**.

**Table 13-3 Parameter Description**

MVS Parameter Name	Device Parameter Name	Description
Device Key	Action Control → Action Device Key	The parameter value should be the same.

MVS Parameter Name	Device Parameter Name	Description
Group Key	Action Control → Action Group Key	The parameter value should be the same.
Group Mask	Action Control → Action Group Mask	The bitwise AND operation of the <b>Group Mask</b> against the <b>Action Group Mask</b> feature should results in non-zero.

8. Enable **Scheduled**.
9. Click  in **Benchmark Camera** to select one device as benchmark device. Once benchmark device is selected, other devices keep time synchronization with it.
10. (Optional) Enter **Delay Time** according to actual demands.

 **Note**

- The delay time should NOT be shorter than the maximum time required to transmit the command across the network.
- When the benchmark device receives the command, all devices will trigger certain actions simultaneously after the specified delay time.

11. (Optional) Enable **Periodically Send** to enable the client to send commands periodically, and enter **Sending Interval** according to actual demands.

 **Note**

The default value of sending interval is 1000 ms, and its range is from 1 ms to 3600000 ms.

12. (Optional) Enable **Request Acknowledgement** to display the acknowledgement messages.
13. Click **Start Sending**.

## 13.4 File Access Control

 **Note**

The file access control function may differ by device model.

The file access function can import or export the device's feature files and save them in mfa format. The supported feature files include **User Set 1/2/3**, **DPC**, **LUT Luminance 1/2/3**, and **License Notice**.

**Steps**

1. Select a device in the device list, and click  to open the file access dialogue box.

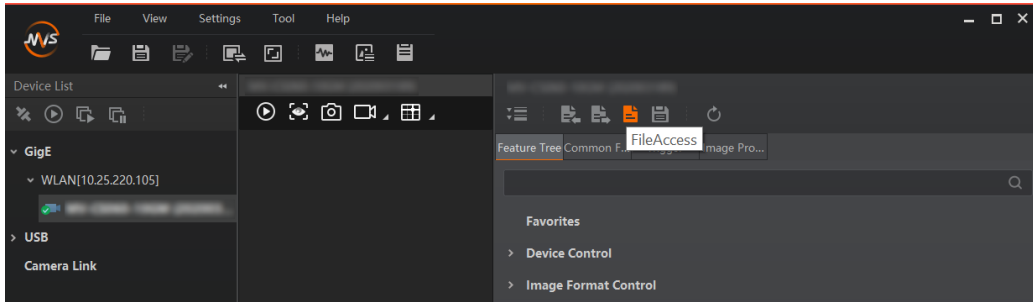

**Figure 13-8 File Access**

2. Select **Device Feature** and click **Import** or **Export**.

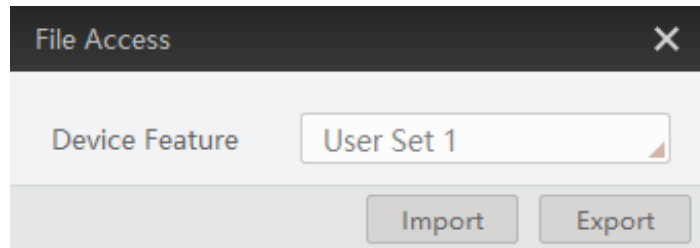

**Figure 13-9 Import or Export**

3. Select a mfa file from local PC to import or select a saving path and enter file name to save and export.

---

## Note

- If **User Set 1/2/3** is selected as device feature, you need to load the corresponding user set you selected to take effect.
  - If **LUT Luminance 1/2/3** is selected as device feature, and they will take effect only when you select the same parameters in LUT Selector.
  - If **DPC** is selected as device feature, and it will take effect immediately.
  - **License Notice** supports exporting only.
  - Importing and exporting the device feature among the same model of devices are supported.
- 

## 13.5 Event Control

---

### Note

The event control function may differ by device model.

---

The event control can record events happen to the device and allow you to view them.

### Steps

1. Go to **Event Control** → **Event Selector**, and select **Event Selector** according to actual demands.



## Note

The specific events may differ by device models.

---

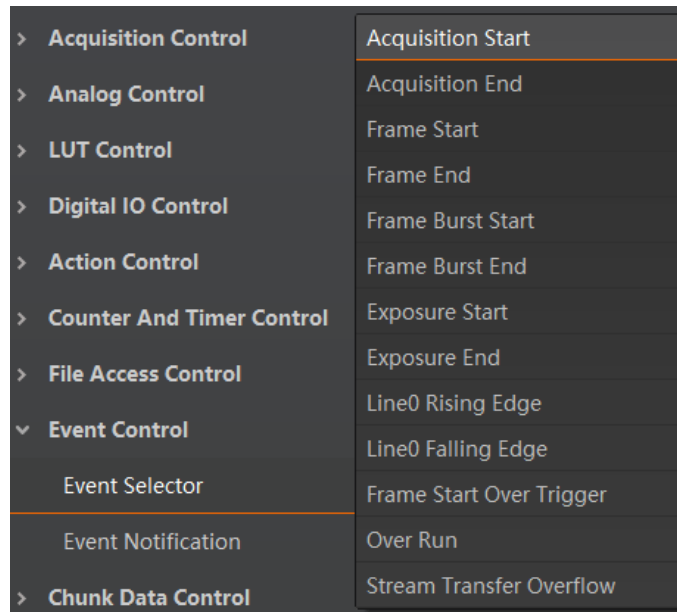

**Figure 13-10 Event Selector**

2. Select **Notification On** as **Event Notification** to output event.

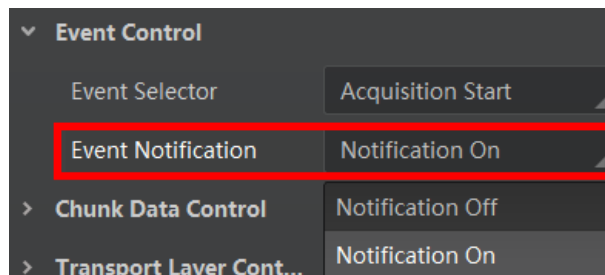

**Figure 13-11 Set Event Control**

3. Right click the connected device and click **Event Monitor**.

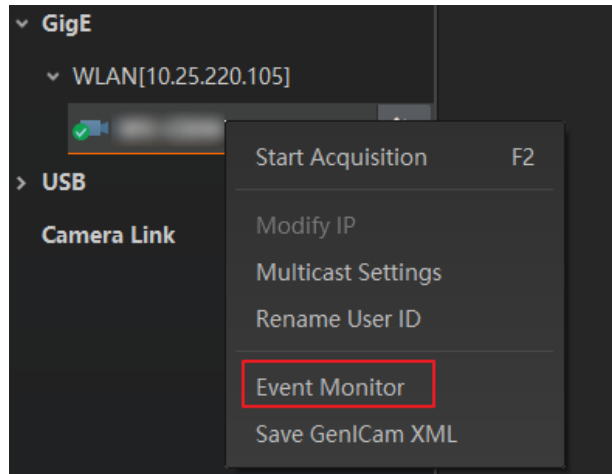

**Figure 13-12 Event Monitor**

4. Check **Messaging Channel Event**, and view the specific event after the device starts live view.

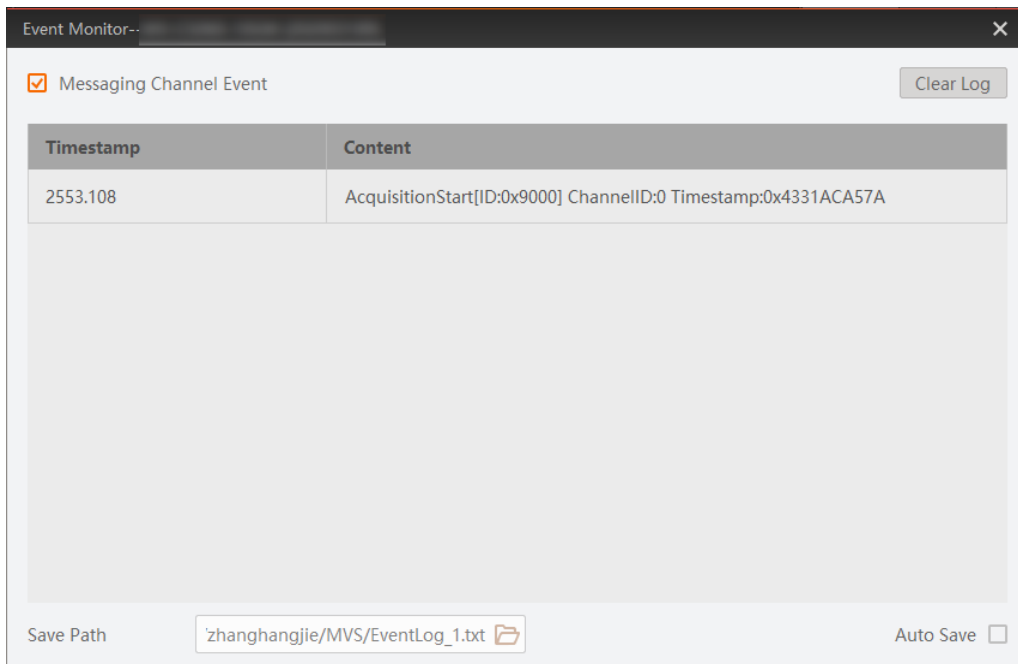

**Figure 13-13 Event Monitor Window**

## 13.6 Transport Layer Control

You can go to **Transport Layer Control** to view the device's payload size, GenCP version, etc.

---

### Note

The specific parameters of transport layer control may differ by device models.

---

**Table 13-4 Parameters of Transport Layer Control**

Parameter	Read/Write	Description
Payloade Size	Read Only	It is the device's load size.
GenCP Version Major	Read Only	It is the major version in GenCP version.
GenCP Version Minor	Read Only	It is the minor version in GenCP version.
GEV Device Mode Is Big Endian	Read Only	It is the endianness in device's register.
GEV Device Mode Character Set	Read Only	It is the character set in device's register.
GEV Interface Selector	Read Only	It sets which physical network interface to be controlled.
GEV MAC Address	Read Only	It is the MAC address of the network interface.
GEV Supported Option Selector	Read & Write	It selects the GEV option to interrogate for existing support.
GEV Supported Option	Read Only	It indicates whether the selected GEV option is supported or not.
GEV Current IP Configuration LLA	Read Only	It indicates whether the Link Local Address IP configuration scheme is activated on the given network interface.
GEV Current IP Configuration DHCP	Read & Write	It indicates whether the DHCP IP configuration scheme is activated on the given network interface.
GEV Current IP Configuration Persistent IP	Read & Write	It indicates whether persistent IP configuration scheme is activated on the given network interface.
DEV PAUSE Frame Reception	Read & Write	It controls whether incoming pause frames are handled on the given logical link.
GEV Current IP Address	Read Only	It is the current IP address for the given network interface.
GEV Current Subnet Mask	Read Only	It is the current subnet mask of the given interface.
GEV Current Default Gateway	Read Only	It is the default gateway IP address to be used on the given network interface.
GEV First URL	Read Only	It is the first choice of URL for the XML device description file.

## GigE Area Scan Camera User Manual

Parameter	Read/Write	Description
GEV Second URL	Read Only	It is the second choice of URL to the XML device description file.
GEV Number of Interfaces	Read Only	It indicates the number of physical network interfaces supported by this device.
GEV Persistent IP Address	Read & Write	It indicates the persistent IP address for this network interface. It is only used when the device boots with the persistent IP configuration scheme.
GEV Persistent Subnet Mask	Read & Write	It indicates the persistent subnet mask associated with the persistent IP address on this network interface. It is only used when the device boots with the persistent IP configuration scheme.
GEV Persistent Default Gateway	Read & Write	It indicates the persistent default gateway for this network interface. It is only used when the device boots with the persistent IP configuration scheme.
GEV Link Speed	Read Only	It indicates the speed of transmission negotiated by the given network interface in Mbps.
GEV Message Channel Count	Read Only	It indicates the number of message channels supported by this device.
GEV Stream Channel Count	Read Only	It indicates the number of stream channels supported by this device.
GEV Heartbeat Timeout (ms)	Read & Write	It indicates the current heartbeat timeout in milliseconds.
GEV Heartbeat Disable	Read & Write	It disables the GEV Heartbeat.
GEV Timestamp Tick Frequency (Hz)	Read Only	It indicates the number of timestamp ticks in 1 second (frequency in Hz).
Timestamp Control Latch	Read & Write	It latches the current timestamp value of the device.
Timestamp Control Reset	Read & Write	It resets the timestamp value for the device.
Timestamp Control Latch Reset	Read & Write	It resets the timestamp control latch.

## GigE Area Scan Camera User Manual

Parameter	Read/Write	Description
Timestamp Value	Read Only	It is a read only element. It indicates the latched value of the timestamp.
GEV CCP	Read & Write	It controls the device access privilege of an application.
GEV Stream Channel Selector	Read Only	It selects the stream channel to control.
GEV SCP Interface Index	Read Only	It is the Index of network interface to be used.
GEV SCP Host Port	Read & Write	It is the host port of the channel
GEV SCP Direction	Read Only	It transmits or receives the channel.
GEV SCPS Fire Test Packet	Read Only	It sends a test packet.
GEV SCPS Do Not Fragment	Read & Write	The state of this feature is copied into the "do not fragment" bit of the IP header of each stream packet.
GEV SCPS Big Endian	Read Only	It is the Endianness of multi-byte pixel data for this stream.
GEV SCPS Packet Size(B)	Read & Write	It specifies the stream packet size (in bytes) to send on this channel.
GEV SCPD	Read & Write	It indicates the delay (in timestamp counter units) to insert between each packet for this stream channel.
GEV SCDA	Read & Write	It indicates the destination IP address for this stream channel.
GEV SCSP	Read Only	It indicates the source UDP port address for this stream channel.
GEV MCP Host Port	Read & Write	It controls the port to which the device must send messages. Setting this value to 0 closes the message channel.
GEV MCDA	Read & Write	It controls the destination IP address for the message channel.
GEV MCTT (ms)	Read & Write	It provides the transmission timeout value in milliseconds.
GEV MCRC	Read & Write	It controls the number of retransmissions allowed when a message channel

Parameter	Read/Write	Description
		message times out.
GEV MCSP	Read Only	It indicates the source port for the message channel.
Gev IEEE 1588	Read & Write	It enables the IEEE 1588 Precision Time Protocol to control the timestamp register.
Gev IEEE 1588 Status	Read Only	The status of the IEEE 1588 Precision Time Protocol.
Gev GVSP Extended ID Mode	Read & Write	It enables the extended ID mode.

## 13.7 Transfer Control

You can go to **Transfer Control** to view the device’s transfer sources, transfer mode, queue information, etc.

 **Note**

The specific parameters of transfer control may differ by device models.

### 13.7.1 User Controlled Transfer Control

The parameters of user controlled transfer control are shown below.

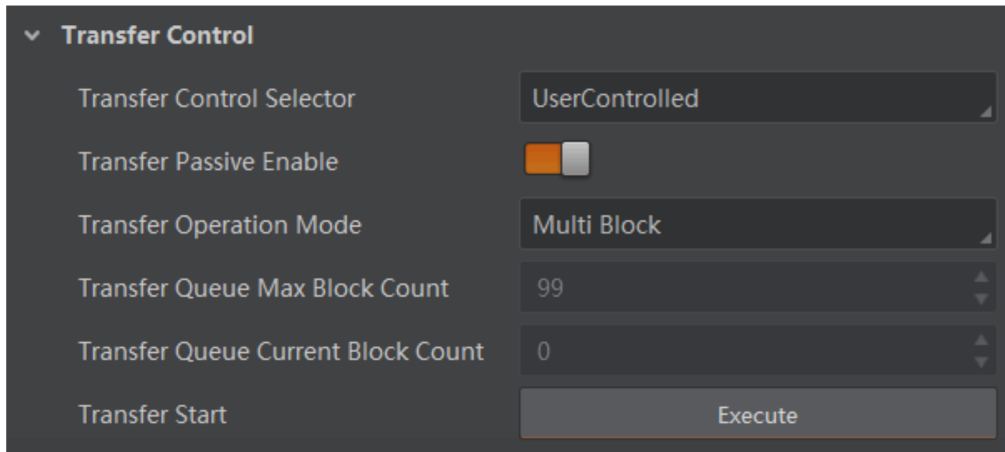



Figure 13-14 User Controlled Transfer Control

Table 13-5 Parameters of User Controlled Transfer Control

Parameter	Read/Write	Description
Transfer Control	Read & Write	It selects the transfer mode.

Parameter	Read/Write	Description
Selector		<ul style="list-style-type: none"> <li>● Basic: In this mode, the device sends images to the client software directly after acquiring images.</li> <li>● User Controlled: In this mode, the device saves images in its internal cache first, and then sends to the client software after acquiring images.</li> </ul>
Transfer Passive Enable	Read & Write	<p>The transfer passive mode will be displayed if it is enabled.</p> <p> <b>Note</b> You should select <b>User Controlled</b> as <b>Transfer Control Selector</b> first.</p>
Transfer Operation Mode	Read & Write	<p>It is the transfer operation mode:</p> <ul style="list-style-type: none"> <li>● Single Block: Click <b>Execute</b> in <b>Transfer Strat</b> to let the device transfer one image each time.</li> <li>● Multi Block: Click <b>Execute</b> in <b>Transfer Strat</b> to let the device transfer multiple images in cache.</li> </ul>
Transfer Queue Max Block Count	Read Only	It displays the max. image quantity that the device's memory can save before the compression.
Transfer Queue Current Block Count	Read Only	It displays current image quantity saved by the memory.
Transfer Start	Read & Write	Click <b>Execute</b> to let the device transfer images.

### 13.7.2 Basic Transfer Control

The parameters of basic transfer control are shown below.

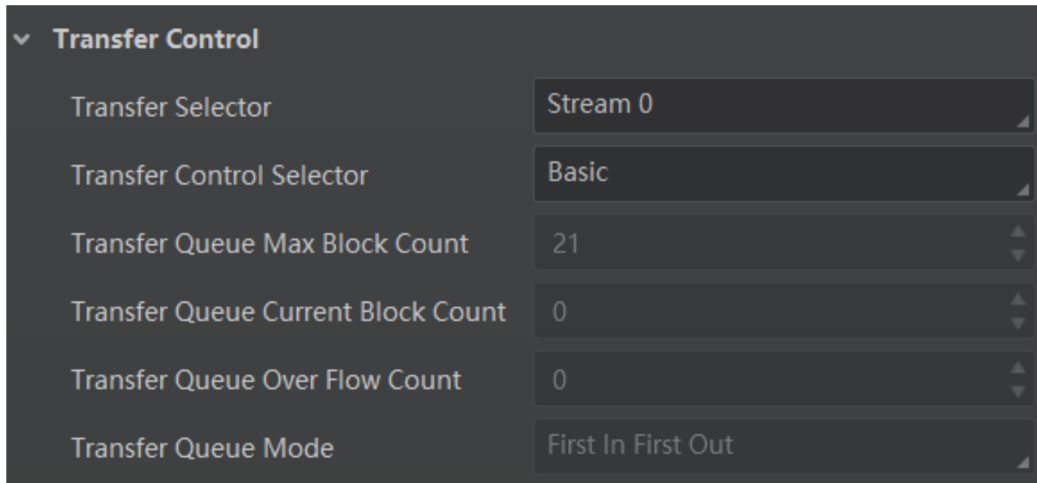

Figure 13-15 Basic Transfer Control

Table 13-6 Parameters of Basic Transfer Control

Parameter	Read/Write	Description
Transfer Selector	Read & Write	It selects the transfer source.
Transfer Control Selector	Read & Write	It selects the transfer mode.
Transfer Queue Max Block Count	Read Only	It displays the max. image quantity that the device's memory can save before the compression.
Transfer Queue Current Block Count	Read Only	It displays current image quantity saved by the memory.
Transfer Queue Over Flow Count	Read & Write	It is the image quantity discarded by FPGA.
Transfer Queue Mode	Read & Write	It is the operating mode of memory queue.

## 13.8 Set Cooling Fan

### Note

- The cooling fan may differ by device models.
- The temperature unit here is Celsius degree.

For device with cooling fan, you can go to **Analog Control** → **Fan Open Threshold** to set fan parameters.

When the device's temperature is higher than the value you set in **Fan Open Threshold**, the



fan starts to work. Otherwise, the fan stops working.

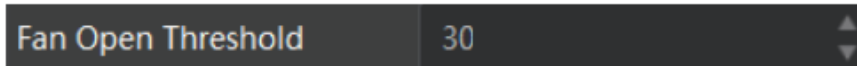

Figure 13-16 Set Cooling Fan

## 13.9 User Set Customization

This function allows you to save or load device settings. The device supports four sets of parameters, including one default set and three user sets, and the relation among four sets of parameters is shown below.

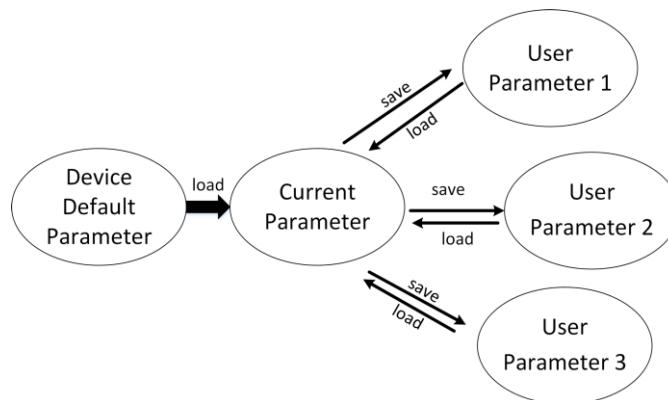

Figure 13-17 Parameter Relation

---

### Note

After setting user parameters, it is recommended to save user parameters and select them as the default parameters.

---

### 13.9.1 Save User Set

#### Steps

1. Go to **User Set Control**, and select a user set in **User Set Selector**.
- 

### Note

Here we take selecting **User Set 1** as an example.

---

2. Click **Execute** in **User Set Save** to save parameter.
3. View **User Set Save Status**:
  - Saving: User parameters are being saved.
  - Ready: User parameters have been saved.

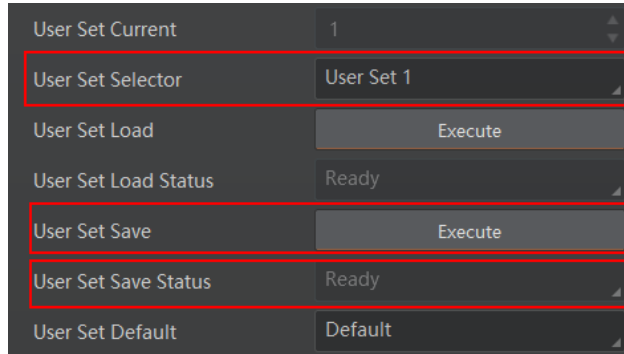

Figure 13-18 Save User Set

## 13.9.2 Load User Set

---

### Note

Loading user set is available only when the device is connected but without live view.

---

### Steps

1. Go to **User Set Control**, and select a user set in **User Set Selector**.

---

### Note

Here we take selecting **User Set 1** as an example.

---

2. Click **Execute** in **User Set Load** to load parameter.

3. View **User Set Load Status**:

- Saving: User parameters are being loaded.
  - Ready: User parameters are to be loaded.
- 

### Note

The parameter of **User Set Load Status** may differ by device models.

---

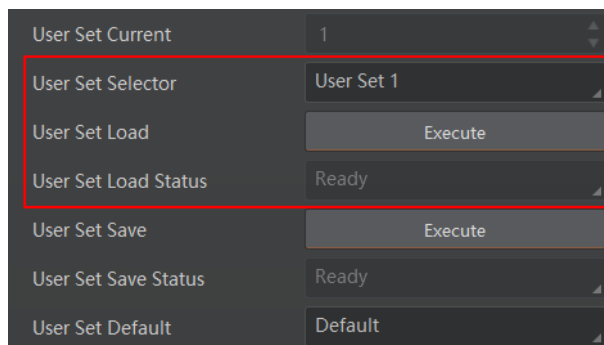

Figure 13-19 Load User Set

### 13.9.3 Set User Default

You can also set default parameter by going to **User Set Control**, and select a user set in **User Set Default**.

 **Note**

Here we take selecting **User Set 1** as an example.

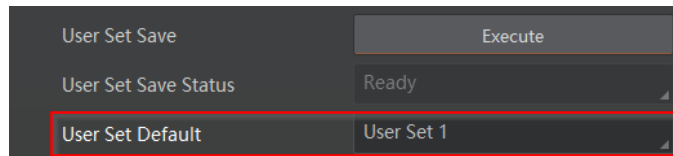

**Figure 13-20 Set User Default**

## 13.10 Multicast Function

The multicast function enables multiple PCs to access the same device at the same time. At the same time, the same device can only be connected by one client in controller and data receiver mode or controller mode, but can be connected by multiple clients in data receiver mode. The multicast mode of each device within the client is controlled individually. The description of three multicast modes is shown below.

**Table 13-7 Multicast Mode Description**

Multicast Mode	Description
Controller and Data Receiver	This mode allows you to read and edit the device's parameters, and get its image data.
Controller	This mode allows you to read and edit the device's parameters, but you cannot get its image data.
Data Receiver	This mode allows you read the device's parameters and get its image data, but you cannot edit its parameters.

When the multicast function is enabled, the device icon on the client software of other PCs will become , and you can connect the device via the data receiver mode. You can set multicast function for both the available device and connected device in the device list, but the specific settings are different.

### 13.10.1 Set Multicast (Available Status)

Follow steps below to set multicast function if the device is in available status.

**Steps**

1. Right click the available device, and click **Multicast Settings**.

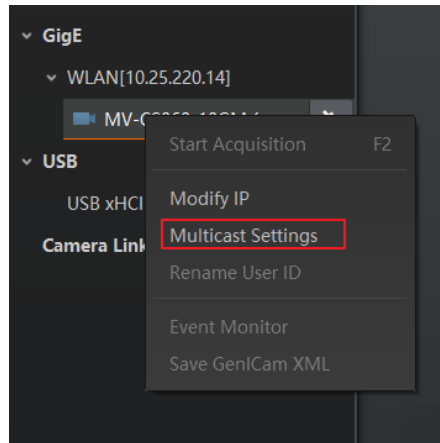

**Figure 13-21 Multicast Settings**

2. Select **Role**, and enter the **IP Address** and **Port**.

---

### **Note**

- The available status device can use multicast function in Controller and Data Receiver mode or Controller mode.
  - The IP address should be class D IP address, and the port ranges from 0 to 65535.
- 

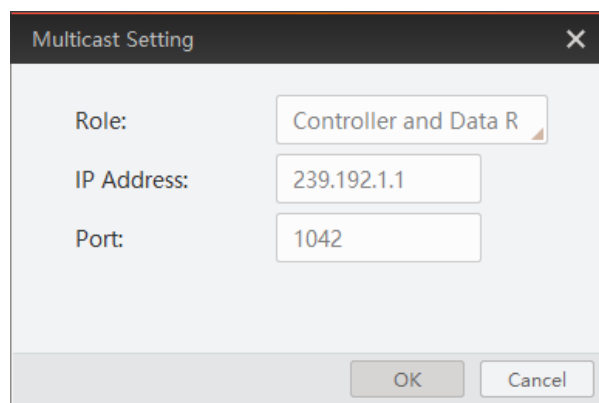

**Figure 13-22 Set Parameters**

3. Click **OK**.

## 13.10.2 Set Multicast (Connected Status)

Follow steps below to set multicast function if the device is in connected status.

### **Steps**

1. Right click the available device, and click **Multicast Settings**.

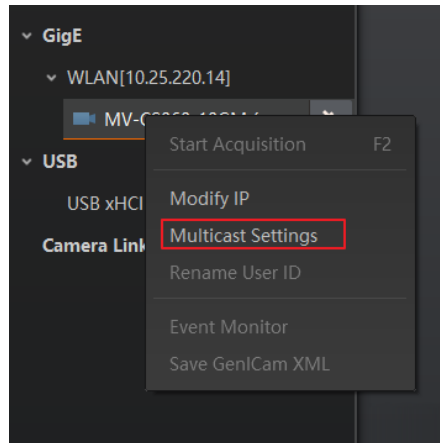

**Figure 13-23 Multicast Settings**

2. Enable the multicast function, and edit the **IP Address** and **Port**.

---

### **Note**

- The connected status device can use multicast function in Controller and Data Receiver mode only.
  - The IP address should be class D IP address, and the port ranges from 0 to 65535.
- 

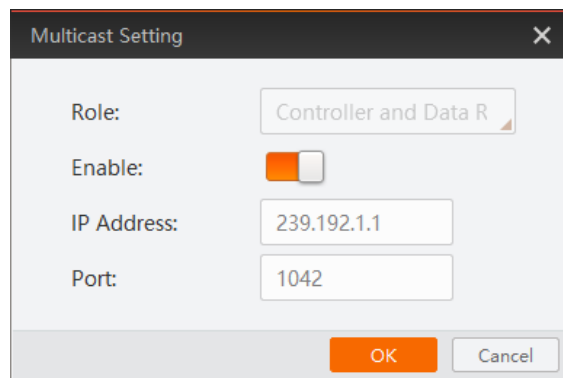

**Figure 13-24 Set Parameters**

3. Click **OK**.

## 13.11 Update Firmware

The device supports updating firmware via the MVS client software.

---

### **Note**

- Make sure that the power cable and others are properly connected.
  - Use the firmware package of the corresponding device model for updating.
- 

### **Steps**

1. Go to **Tool** → **Firmware Updater** to open the update window.

---

2. Select corresponding device type like GigE, USB, or Camera Link.
3. Check  to select the device you want to update.
4. Click  to select update files (.dav files) in the local PC.
5. Click **Update** to start updating.

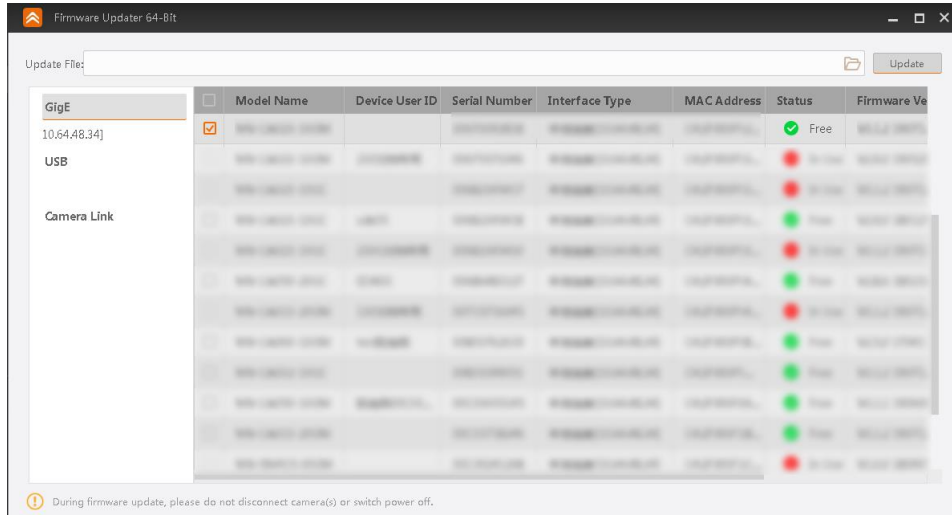

**Figure 13-25 Update Firmware**

---

### Note

- The device will reboot automatically after updating the firmware.
  - The firmware updating process may take a few minutes, please wait patiently.
  - During firmware updating, do not disconnect the device or switch power off.
- 

## 13.12 Encrypt Device via Dongle Tool

---

### Note

- This function may differ by device models.
  - You can contact the technical support to get the dongle tool.
- 

The dongle tool is used to encrypt and decrypt devices for protecting data.

### Steps

1. Run the dongle tool, and click **Enumerate**.
2. Click **Create Random Secret Key** or enter it manually.
3. Click **Write Secret Key**.
4. Enter plaintext that should be no more than 15 characters, and click **Verify**.

# GigE Area Scan Camera User Manual

---

The screenshot shows a software interface for encrypting a device via a dongle. It is divided into four steps:

- Step 1 : Enumerate**: A button labeled "Enumerate" is next to a dropdown menu.
- Step 2 : Enter Secret Key**: A text input field is present. Below it is a button labeled "Create Random Secret Key". To the right of this button is a note: "The encryption key is composed of 64 hexadecimal digits, or an English string of 32 characters. The user can manually enter or click Create Encryption Key."
- Step 3**: A button labeled "Write Secret Key" is shown.
- Step 4 : Verify and Decrypt**: A text input field contains the text "Plaintext1234". To its right is a button labeled "Verify". Below this step is a note: "The plaintext is set to the camera, and the camera returns the encrypted one. The encryption tool decrypts the encryption key, and verifies whether the decrypted result is consistent with the plaintext."

**Figure 13-26 Encrypt Device via Dongle Tool**

## Chapter 14 FAQ (Frequently Asked Question)

### 14.1 Why the client software cannot list devices?

#### Reason

- The device is not powered on.
- Incorrect network cable connection.

#### Solution

Check the device's power supply and network connection by observing the device's indicator and network link indicator.

### 14.2 Why device connection fails after the device is listed in the client software?

#### Reason

- The device and the client software are not in the same network segment.
- The device has been connected by other programs.

#### Solution

- Use IP configurator tool to edit the device's IP address to make sure that the device and the client software are in the same network segment.
- Disconnect the device with other programs, and reconnect it to the client software.

### 14.3 Why the live view is back?

#### Reason

- The device's lens aperture is not removed.
- The device exception occurs.

#### Solution

- Remove the device's lens aperture.
- Power off and restart the device.



## **14.4 Why the device cannot be triggered although the live view is normal?**

### **Reason**

- The trigger mode is not enabled or the device is not triggered.
- Incorrect trigger wiring.

### **Solution**

- Enable the trigger mode and make sure that the selected trigger source matches with the corresponding I/O signal.
- Check if the input of trigger signal and wiring are correct or not.

## **14.5 Why the network changes from GigE Ethernet to Fast Ethernet?**

### **Reason**

The network cable may be damaged.

### **Solution**

Check the network cable, and replace it if it is damaged.

## Appendix A Device Parameter Index

Table Appendix A-1 Device Parameter Index

Attribute	Parameters	Section
Device Control	Device Type	Section Device Control
	Device Scan Type	
	Device Vendor Name	
	Device Model Name	
	Device Manufacturer Info.	
	Device Version	
	Device Firmware Version	
	System of Chip Version	
	Device Serial Number	
	Device ID	
	Device User ID	
	Device Uptime (s)	
	Board Device Type	
	Device Connection Selector	
	Device Type	
	Device Scan Type	
	Device Vendor Name	
	Device Model Name	
	Device Manufacturer Info.	
	Device Version	
	Device Firmware Version	
	System of Chip Version	
	Device Serial Number	
	Device ID	
	Device User ID	
Device Uptime (s)		

## GigE Area Scan Camera User Manual

---

Attribute	Parameters	Section
	Board Device Type	
	Device Connection Selector	
	Device Connection Speed (Mbps)	
	Device Link Selector	
	Device Link Speed (Mbps)	
	Device Link Connection Count	
	Device Link Heartbeat Mode	
	Device Stream Channel Count	
	Device Stream Channel Selector	
	Device Stream Channel Type	
	Device Stream Channel Link	
	Device Stream Channel Endianness	
	Device Stream Channel Packet Size (B)	
	Device Event Channel Count	
	Device Character Set	
	Device Reset	
	Device Temperature Selector	
	Device Temperature	
	Relative Humidity	
	Device Fan Enable	
	TEC Enable	
	TEC Temperature	
	TEC Voltage	
	Find Me	
	Device Max Throughput (Kbps)	
	Device PJ Number	
HB Abnormal Monitor		
HB Version		
Image Format Control	Width Max	Section View Resolution
	Height Max	

Attribute	Parameters	Section
	Region Selector	Section Set ROI
	Region Destination	
	Width	
	Height	
	Offset X	
	Offset Y	
	Reverse X	Section Set Image Reverse
	Reverse Y	
	ADC Bit Depth	Section Set Pixel Format
	Pixel Format	
	Super Bayer Enable	Set Super Bayer
	Pixel Size	Section Set Pixel Format
	Image Compression Mode	Section Set Image Compression Mode
	High Bandwidth Mode	
	Test Pattern Generator Selector	Section Set Test Pattern
	Test Pattern	
	Binning Selector	Section Set Binning
	Binning Horizontal	
	Binning Vertical	
	Binning Mode	
Decimation Horizontal	Section Set Decimation	
Decimation Vertical		
Embedded Image Info Selector	Section Embed Information into Image	
Frame Spec Info		
Acquisition Control	Acquisition Mode	Section Set Acquisition Mode
	Acquisition Start	
	Acquisition Stop	
	Acquisition Burst Frame Count	Section Set Frame Rate
	Acquisition Frame Rate (Fps)	
	Acquisition Frame Rate Control Enable	

Attribute	Parameters	Section
	Resulting Frame Rate (Fps)	
	Reference Frame Rate	
	Overlap Mode	Section Set Overlap Mode
	Trigger Selector	Section Set Trigger Source
	Trigger Mode	
	Trigger Software	
	Trigger Source	
	Trigger Activation	
	Trigger Delay ( $\mu$ s)	
	Trigger Cache Enable	Section Sensor Shutter Mode
	Sensor Shutter Mode	
	Exposure Time Mode	Section Set Exposure Time Mode
	Exposure Mode	Section Set Exposure Auto
	Exposure Time ( $\mu$ s)	
	Exposure Auto	
	Auto Exposure Time Lower Limit ( $\mu$ s)	
	Auto Exposure Time Upper Limit ( $\mu$ s)	
	Full Frame Transmission	Set Full Frame Transmission
	WDR Mode	Section Set WDR Mode
	WDR Level	
	HDR Enable	Section Set HDR
	HDR Selector	
	HDR Shutter ( $\mu$ s)	
HDR Gain		
Analog Control	Gain (dB)	Section Set Analog Gain
	Gain Auto	
	Auto Gain Lower Limit	

## GigE Area Scan Camera User Manual

---

Attribute	Parameters	Section
	Auto Gain Upper Limit	
	Digital Shift	Section Set Digital Gain
	Digital Shift Enable	
	Sensor Mode	Section Set Sensor Mode
	Brightness	Section Set Brightness
	Black Level	Section Set Black Level
	Black Level Enable	
	Balance White Auto	Section Set White Balance
	AWB Color Temperature Mode	
	Balance Ratio Selector	
	Balance Ratio	
	Gamma	Section Set Gamma Correction
	Gamma Selector	
	Gamma Enable	
	Sharpness	Section Set Sharpness
	Sharpness Enable	
	Digital Noise Reduction Mode	Section Set Digital Noise Reduction
	Denoise Strength	
	Noise Correct	
	Channel Correct Mode	Section Set Channel Correct Mode
	Fan Open Threshold	Section Set Cooling Fan
	Contrast Ratio	Section Set Contrast Ratio
	Contrast Ratio Enable	
	Auto Function AOI Selector	Section Set AOI
	Auto Function AOI Width	
	Auto Function AOI Height	
	Auto Function AOI Offset X	
	Auto Function AOI Offset Y	
	Auto Function AOI Usage Intensity	

Attribute	Parameters	Section
	Auto Function AOI Usage White Balance	
Color Transformation Control	CCM Enable	Section Set Color Transformation Control
	Color Transformation Selector	
	Color Transformation Enable	
	Color Transformation Value Selector	
	Color Transformation Value	
	Hue	Section Set Hue
	Hue Enable	Section Set Saturation
	Saturation	
Saturation Enable		
Super Palette Control	Super Palette Enable	Section Set Super Palette Control
	Super Palette Selector	
	Super Palette Hue	
	Super Palette Saturation	
LUT Control	LUT Selector	Section Set LUT
	LUT Enable	
	LUT Index	
	LUT Value	
	LUT Save	
Shading Correction	Shading Selector	Section Set Shading Correction
	Activate Shading	
	NUC Enable	
	FPNC Enable	
	PRNUC Enable	
	LSC Enable	
Digital IO Control	Line Selector	Section Trigger Output
	Line Mode	
	Line Inverter	
	Line Status	
	Line Status All	

Attribute	Parameters	Section
	Line Debouncer Time ( $\mu$ s)	
	Line Source	
	Strobe Enable	
	Strobe Line Duration ( $\mu$ s)	
	Strobe Line Delay ( $\mu$ s)	
	Strobe Line Pre Delay ( $\mu$ s)	
Action Control	Action Unconditional Mode	Section Set Action Command
	Action Device Key	
	Action Queue Size	
	Action Selector	
	Action Group Mask	
	Action Group Key	
Counter and Timer Control	Counter Selector	Section Set and Execute Counter Trigger
	Counter Event Source	
	Counter Reset Source	
	Counter Reset	
	Counter Value	
	Counter Current Value	
File Access Control	File Selector	Section File Access Control
	File Operation Selector	
	File Operation Excute	
	File Open Mode	
	File Operation Status	
	File Operation Result	
	File Size(B)	
Sequencer Control	Sequencer Mode	Section Set Sequencer Control
	Sequencer Configuration Mode	
	Sequencer Feature Selector	
	Sequencer Feature Enable	
	Sequencer Restart	



## GigE Area Scan Camera User Manual

---

Attribute	Parameters	Section
	Sequencer Set Total Number	
	Sequencer Set Selector	
	Sequencer Set Active	
	Sequencer Set Load	
	Sequencer Set Save	
Event Control	Event Selector	Section Event Control
	Event Notification	
Chunk Data Control	Chunk Mode Active	Section Embed Information into Image
	Chunk Selector	
	Chunk Enable	
Transport Layer Control	Payload Size(B)	Section Transport Layer Control
	GEV Version Major	
	GEV Version Minor	
	GEV Device Mode Is Big Endian	
	GEV Device Mode Character Set	
	GEV Interface Selector	
	GEV MAC Address	
	GEV Supported Option Selector	
	GEV Supported Option	
	GEV Current IP Configuration LLA	
	GEV Current IP Configuration DHCP	
	GEV Current IP Configuration Persistent IP	
	GEV PAUSE Frame Reception	
	GEV Current IP Address	
	GEV Current Subnet Mask	
	GEV Current Default Gateway	
GEV First URL		
GEV Second URL		
GEV Number Of Interfaces		

## GigE Area Scan Camera User Manual

---

Attribute	Parameters	Section
	GEV Persistent IP Address	
	GEV Persistent Subnet Mask	
	GEV Persistent Default Gateway	
	GEV Link Speed	
	GEV Message Channel Count	
	GEV Stream Channel Count	
	GEV Heartbeat Timeout(ms)	
	GEV Heartbeat Disable	
	GEV Timestamp Tick Frequency(Hz)	
	Timestamp Control Latch	
	Timestamp Control Reset	
	Timestamp Control Latch Reset	
	Timestamp Value	
	GEV CCP	
	GEV MCP Host Port	
	GEV MCDA	
	GEV MCTT(ms)	
	GEV MCRC	
	GEV MCSP	
	GEV Stream Channel Selector	
	GEV SCP Interface Index	
	GEV SCP Host Port	
	GEV SCP Direction	
	GEV SCPS Fire Test Packet	
	GEV SCPS Do Not Fragment	
	GEV SCPS Big Endian	
	GEV SCPS Packet Size(B)	
	GEV SCPD	
	GEV SCDA	
	GEV SCSP	

Attribute	Parameters	Section
	GEV IEEE 1588	
	GEV IEEE 1588 Status	
	GEV GVSP Extended ID Mode	
Transfer Control	Transfer Control Selector	Section Transfer Control
	Transfer Passive Enable	
	Transfer Operation Mode	
	Transfer Start	
	Transfer Selector	
	Transfer Control Selector	
	Transfer Queue Max Block Count	
	Transfer Queue Current Block Count	
	Transfer Queue Over Flow Count	
	Transfer Queue Mode	
User Set Control	User Set Current	Section User Set Customization
	User Set Selector	
	User Set Load	
	User Set Load Status	
	User Set Save	
	User Set Default	

## Appendix B Revision History

**Table Appendix B-1 Revision History**

Version	Document No.	Revision Date	Revision Details
V3.5.5	UD32108B	Mar. 6, 2023	<ul style="list-style-type: none"> <li>● Modify section Appearance.</li> <li>● Modify section I/O Connector and Indicator.</li> <li>● Modify section Client Software Layout.</li> <li>● Add section Set Full Frame Transmission.</li> <li>● Modify section Device Control.</li> <li>● Modify section File Access Control.</li> <li>● Modify section Transport Layer Control.</li> <li>● Modify section Device Parameter Index.</li> </ul>
V3.5.4	UD31188B	Dec. 5, 2022	<ul style="list-style-type: none"> <li>● Add section Set Super Bayer.</li> <li>● Modify section Set Binning.</li> <li>● Modify section Set Gamma Correction.</li> <li>● Modify section Set Sharpness.</li> <li>● Modify section Set Contrast Ratio.</li> <li>● Modify section Set Super Palette Control.</li> <li>● Modify section Set LUT.</li> </ul>
V3.5.3	UD29959B	Sep. 5, 2022	<ul style="list-style-type: none"> <li>● Modify section Safety Instructions.</li> <li>● Add section Set Overlap Mode.</li> <li>● Modify section Set Pixel Format.</li> <li>● Add section Set Sequencer Control and HDR.</li> <li>● Modify section Set Color Transformation Control.</li> <li>● Modify section File Access Control.</li> <li>● Modify section Transfer Control.</li> <li>● Modify section User Set Customization.</li> </ul>
V3.5.1	UD29515B	July 25, 2022	<ul style="list-style-type: none"> <li>● Modify section Appearance.</li> <li>● Modify section I/O Connector and Indicator.</li> </ul>
V3.5.0	UD28667B	May 30, 2022	<ul style="list-style-type: none"> <li>● Modify section Appearance.</li> <li>● Modify section I/O Connector and Indicator.</li> <li>● Modify Section I/O Electrical Features and Wiring.</li> <li>● Add Section WDR Mode.</li> <li>● Add Section Sensor Mode</li> </ul>
V3.4.50	UD26223B	Nov. 11, 2021	Modify section I/O Wiring.
V3.4.43	UD24711B	Jul. 12, 2021	<ul style="list-style-type: none"> <li>● Add section Super Palette Control.</li> <li>● Add section Encrypt Device via Dongle Tool.</li> </ul>
V3.4.24	UD22445B	Dec. 24, 2020	Add Section Set Color Adjustment.
V3.4.20	UD21233B	Sep. 27, 2020	<ul style="list-style-type: none"> <li>● Modify Section Client Software Layout.</li> <li>● Modify Section Set Frame Rate.</li> </ul>

## GigE Area Scan Camera User Manual

---

Version	Document No.	Revision Date	Revision Details
			<ul style="list-style-type: none"><li>● Add Section Set Image Compression Mode.</li><li>● Add Section Set Digital Noise Reduction.</li><li>● Modify Section Hue.</li><li>● Modify Section Saturation.</li><li>● Modify Section Device Control.</li><li>● Add Section Transfer Control.</li></ul>
V3.4.9	UD19137B	April 8, 2020	<ul style="list-style-type: none"><li>● Add Section Overview.</li><li>● Modify Section Appearance.</li><li>● Modify Section Client Software Layout.</li><li>● Add Section Sensor Shutter Mode.</li><li>● Modify Section Set Pixel Format.</li><li>● Modify Section Set Test Pattern.</li><li>● Add Section Set Shading Correction.</li><li>● Modify Section Transport Layer Control.</li></ul>
V1.0.1	UD15735B	Jul. 24, 2019	<ul style="list-style-type: none"><li>● Add Section Set Anyway Trigger.</li><li>● Modify Section Set Action Command.</li><li>● Add Section Set Color Transformation Control.</li></ul>
V1.0.0	UD12911B	Jan. 9, 2019	Original version.



See Far, Go Further